

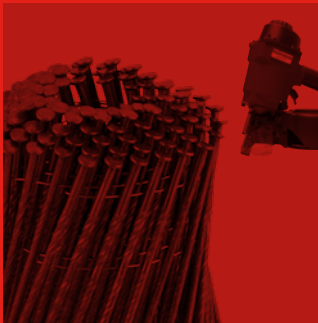

Sistemas de fijación  
Sistemas de fixações  
Stapling & nailing systems  
Systèmes de fixations

CATÁLOGO · CATALOGUE VS 3.42



# 1



**GRAPAS  
AGRAFAS  
STAPLES  
AGRAFES**

# 2



**CLAVOS  
PREGOS  
NAILS  
CLOUS**

# 3



**ANILLADAS  
ANILHADOS  
HOG RINGS  
ANNELÉES**

mod 80	2	Pin 0,6 JSI	32	mod HR	54
mod 3	3	Microbrad 0,6	33	mod RT	55
mod G3 (71)	4	Pin 0,8	34	mod YM13	56
mod N3	5	Minibrad 0,8	35	mod CL23	56
mod 5	6	Pin LSI / Brad LSII	36	mod C20	57
mod N5	7	Brad AX 1,2	37	mod CL12	58
mod 75	8	Brad 1,53	38	mod YK11	59
mod 97 (N7)	9	Brad 1,83	39	mod C17	60
mod N3045	10	T 2,2	40	mod A18 coil / mod A19 coil	61
mod N4450 (90)	11	DA	41	mod A20	62
mod G4450	12	EC-GC-HF	42	mod A18 / A16	64
mod 92	13	Holz-Her	43	omega 20 / omega 16	66
mod G5562	14	Coil 1,6	44	mod A40	68
mod S4	15	Coil 2,0 - 2,1	45	mod CL25	69
mod 14	16	Coil 2,2 - 2,3	46	mod G29 / mod G35	70
mod W5562	17	Coil 2,5	47	mod CL50	72
mod G6774	18	Coil 2,9	48	Grampillones	73
mod RM (35)	19	Coil 3,1	49	PREGOS U	
mod Top	20	Coil 3,8	50	U-NAILS	
mod Arrow T-50	21	Hojas de sierras	50	GRAMPILLONS	
mod STCR2115	22	Coil roofing	51		
mod STCR5019	23				
Chapa Corrugada	24				
Semclamp	25				
mod B6 / mod B10	26				
Tacos 13	27				
mod Roc77	28				
mod 9	29				
mod 110	29				

# 4



**COMPRESORES**  
**COMPRESSORES**  
**COMPRESSORS**  
**COMPRESSEURS**

# 5



**ADHESIVOS Y ESPUMA**  
**ADESIVOS E ESPUMAS**  
**ADHESIVES AND FOAM**  
**ADHÉSIFS ET MOUSSE**

# 6



**TORNILLOS**  
**PARAFUSOS**  
**SCREWS**  
**VIS**

6-15	76	Hot-melt, ø12mm	80	Tirafondo rosca-madera	88
6-25	76	Hot-melt, ø15mm	81	Pozi bicromatado	
PC1010	77	Hot-melt, ø18mm	82	LAG PARAFUSO DE MADEIRA POZI BICROMATADO	
PC0968	77	Hot-melt, ø43mm + cartuchos	83	POZI DICHROMATE LAG SCREW	
		Hot-melt, industrial	84	VIS À BOIS FENDUE BICHROMATÉ EMPREINTE POZI	
		Espumas	85	Tirafondo rosca-madera Pozi cincado	88
		FOAMS		LAG PARAFUSO DE MADEIRA POZI ZINCO	
		MOUSSES		ZINC LAG SCREW POZI	
				VIS À BOIS FENDUE ZINGUÉ EMPREINTE POZI	
				Tirafondo rosca-madera	89
				Torx bicromatado	
				LAG PARAFUSO DE MADEIRA TORX BICROMATADO	
				TORX DICHROMATE LAG SCREW	
				VIS À BOIS FENDUE BICHROMATÉ EMPREINTE TORX	
				Tornillo DIN 571 cincado	89
				PARAFUSO ZINCO DIN 571	
				ZINC SCREW DIN 571	
				VIS DIN 571 ZINGUÉ	
				Tirafondo rosca-madera	90
				Torx FWS bicromatado	
				LAG PARAFUSO DE MADEIRA	
				TORX FWS BICROMATADO	
				TORX FWS DICHROMATE LAG SCREW	
				VIS À BOIS TORX FWS BICHROMATÉ	
				Puntas para atornillar	90
				BITES PARAFUSO	
				SCREW TIPS	
				POINTES DE VIS	
				ADS-UF	91
				mod ADS-2025 RD	91
				mod ADS-2010 RD	91
				mod ADS-2040 RD	91
				mod ADS-2045 RD	91

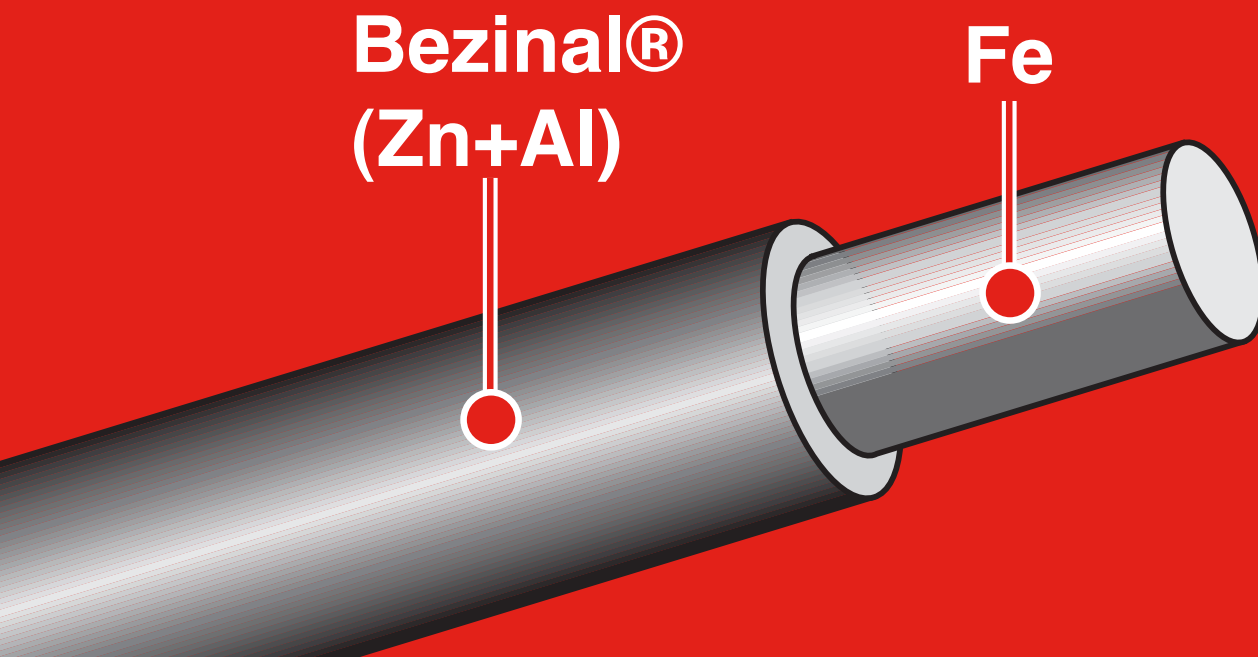

## **E** Revestimiento Bezinal®

**Bezinal® (Bekaert Zinc Aluminum)** es una aleación eutéctica de 95% de zinc + 5% de aluminio (+ metal de Misch) que presenta una destacada resistencia a la corrosión en el revestimiento y adhesión (“formabilidad”). El producto proporciona excelentes propiedades de resistencia a la corrosión a partir de la combinación de las características anticorrosivas de la pasivación presentes en el aluminio junto con la protección que ofrece el contenido de zinc de la aleación.

**BEKAERT** asegura que todas las propiedades excepcionales que ofrece Bezinal® están garantizados por el estricto cumplimiento de la AST B750 (Galfan) estándar que especifica las cantidades y límites para la mezcla homogénea entre el aluminio y los elementos de zinc.

## **P** Revestimiento Bezinal®

**BEZINAL® (BEkaert ZINc ALuminium)** é uma liga eutéctica com 95% de Zinco + 5% de Alumínio (+ Mischmetal) que apresenta uma resistência à corrosão e uma aderência notáveis (“formabilidade”). O produto proporciona as propriedades excepcionais de resistência à corrosão, mediante a combinação de características de passivação da corrosão presentes no alumínio, juntamente com a protecção anódica proporcionada pelo conteúdo de zinco da liga.

A **BEKAERT** assegura que todas as propriedades excepcionais proporcionadas pela liga Bezinal® são garantidas pela conformidade rigorosa com a norma AST B750 (Galfan) que especifica as quantidades e limites da mistura homogénea entre os elementos de alumínio e de zinco.

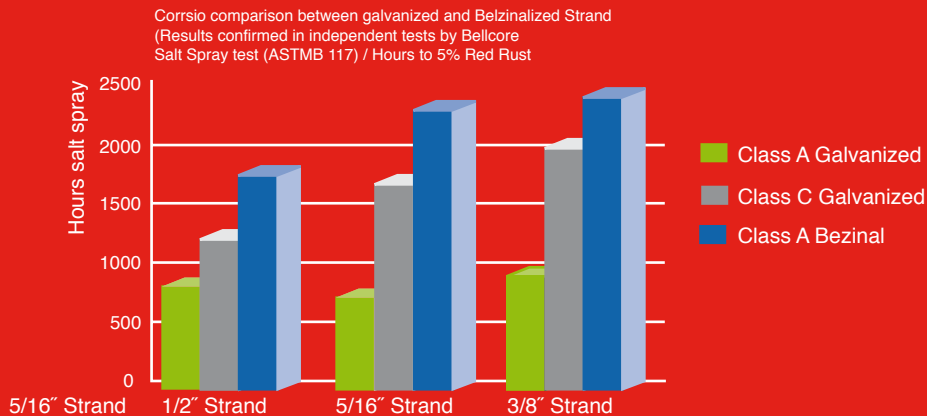
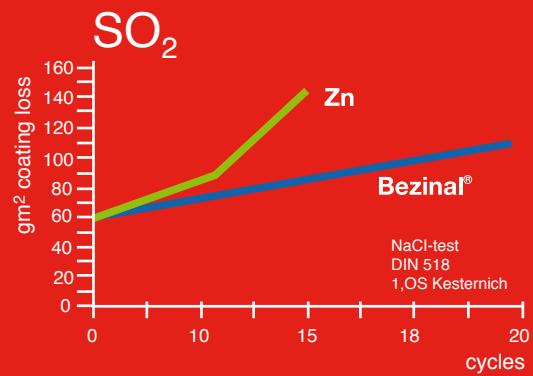
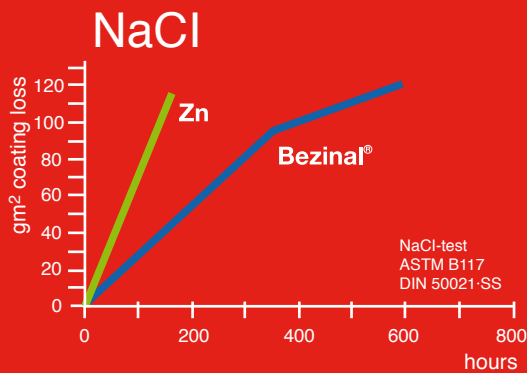

## UK Bezinal coating®

**BEZINAL® (BEkaert ZINc ALuminium)** is a 95% Zinc + 5% Aluminum (+Mischmetal) eutectic alloy that exhibits remarkable coating corrosion resistance and adhesion ("formability"). The product provides the exceptional corrosion resistant properties by the combination of the passivation corrosion characteristics present with aluminum together with the sacrificial protection offered by the zinc content of the alloy.

**BEKAERT** ensures that all of the exceptional properties offered by Bezinal® are guaranteed by strict compliance with the AST B750 (Galfan) standard which specifies the quantities and limits for the homogeneous mix between the aluminum and zinc elements.

## F Revêtement Bezinal®

**Bezinal® (Bekaert zinc aluminium)** est un alliage eutectique de zinc 95% + 5% d'aluminium (+ Misch métal) qui a une résistance exceptionnelle à la corrosion dans le revêtement et l'adhérence («formabilité»). Le produit offre une excellente résistance à la corrosion par la combinaison des caractéristiques de passivation de corrosion présents dans l'aluminium avec la protection accordée par la teneur en zinc de l'alliage.

**BEKAERT** témoigne que toutes les propriétés exceptionnelles offrant ® Bezinal sont garantis par le strict respect de l'AST B750 (Galfan) standard qui précise les montants et les limites du mélange homogène entre l'aluminium et des éléments de zinc.

# E Números de calibre dividido y equivalentes decimal

## P Números calibre dividido e equivalentes decimal

## UK Split gauge numbers and decimal equivalents

## F Numéros de calibre divisé et équivalents décimaux

	CALIBRE BITOLA GAUGE JAUGE	Ø PULGADA Ø POLEGADA Ø INCH Ø POUÇES	ØMM ØMM ØMM ØMM		CALIBRE BITOLA GAUGE JAUGE	Ø PULGADA Ø POLEGADA Ø INCH Ø POUÇES	ØMM ØMM ØMM ØMM		CALIBRE BITOLA GAUGE JAUGE	Ø PULGADA Ø POLEGADA Ø INCH Ø POUÇES	ØMM ØMM ØMM ØMM
7/0	7/0	0,490	12,446	10	10	0,135	3,429	26	26	0,018	0,46
	1/4	0,483	12,268		1/4	0,131	3,327		1/4	0,018	0,455
	1/2	0,476	12,090		1/2	0,128	3,251		1/2	0,018	0,450
	3/4	0,469	11,913		3/4	0,124	3,15		3/4	0,018	0,445
6/0	6/0	0,462	11,722	11	11	0,121	3,061	27	27	0,017	0,439
	1/4	0,454	11,532		1/4	0,117	2,972		1/4	0,017	0,432
	1/2	0,446	11,328		1/2	0,113	2,870		1/2	0,017	0,427
	3/4	0,438	11,125		3/4	0,109	2,769		3/4	0,017	0,419
5/0	5/0	0,431	10,935	12	12	0,106	2,68	28	28	0,016	0,411
	1/4	0,421	10,693		1/4	0,102	2,591		1/4	0,016	0,404
	1/2	0,412	10,465		1/2	0,099	2,515		1/2	0,016	0,396
	3/4	0,403	10,236		3/4	0,095	2,413		3/4	0,015	0,389
4/0	4/0	0,394	10,003	13	13	0,092	2,324	29	29	0,015	0,381
	1/4	0,386	9,804		1/4	0,089	2,261		1/4	0,015	0,376
	1/2	0,378	9,601		1/2	0,086	2,184		1/2	0,015	0,368
	3/4	0,370	9,398		3/4	0,083	2,108		3/4	0,014	0,363
3/0	3/0	0,363	9,208	14	14	0,080	2,032	30	30	0,014	0,3556
	1/4	0,355	9,017		1/4	0,078	1,982		1/4	0,014	0,35052
	1/2	0,347	8,814		1/2	0,076	1,930		1/2	0,014	0,351
	3/4	0,339	8,611		3/4	0,074	1,88		3/4	0,013	0,33528
2/0	2/0	0,331	8,407	15	15	0,072	1,829	31	31	0,013	0,33528
	1/4	0,325	8,255		1/4	0,070	1,778		1/4	0,013	0,33274
	1/2	0,190	7,103		1/2	0,067	1,712		1/2	0,013	0,330
	3/4	0,313	7,95		3/4	0,065	1,651		3/4	0,013	0,32512
1/0	1/0	0,307	7,785	16	16	0,063	1,588	32	32	0,013	0,32512
	1/4	0,301	7,645		1/4	0,060	1,524		1/4	0,013	0,32004
	1/2	0,295	7,493		1/2	0,058	1,471		1/2	0,012	0,312
	3/4	0,289	7,341		3/4	0,056	1,422		3/4	0,012	0,30734
1	1	0,283	7,188	17	17	0,054	1,372	33	33	0,012	0,29972
	1/4	0,278	7,061		1/4	0,052	1,321		1/4	0,012	0,2921
	1/2	0,273	6,934		1/2	0,051	1,295		1/2	0,011	0,282
	3/4	0,268	6,807		3/4	0,049	1,247		3/4	0,011	0,27432
2	2	0,263	6,666	18	18	0,048	1,207	34	34	0,010	0,26416
	1/4	0,258	6,553		1/4	0,046	1,166		1/4	0,010	0,25908
	1/2	0,253	6,426		1/2	0,044	1,125		1/2	0,010	0,254
	3/4	0,248	6,299		3/4	0,043	1,082		3/4	0,010	0,24638
3	3	0,244	6,19	19	19	0,010	1,041	35	35	0,010	0,2413
	1/4	0,239	6,071		1/4	0,039	1,001		1/4	0,009	0,23876
	1/2	0,235	5,969		1/2	0,038	0,963		1/2	0,009	0,236
	3/4	0,230	5,842		3/4	0,036	0,922		3/4	0,009	0,23114
4	4	0,225	5,733	20	20	0,035	0,884	36	36	0,009	0,2286
	1/4	0,221	5,613		1/4	0,034	0,864		1/4	0,009	0,22606
	1/2	0,216	5,486		1/2	0,033	0,843		1/2	0,009	0,221
	3/4	0,212	5,385		3/4	0,033	0,826		3/4	0,009	0,21844
5	5	0,207	5,258	21	21	0,032	0,805	37	37	0,009	0,2159
	1/4	0,203	5,156		1/4	0,031	0,783		1/4	0,008	0,21336
	1/2	0,200	5,080		1/2	0,030	0,763		1/2	0,008	0,211
	3/4	0,196	4,978		3/4	0,029	0,747		3/4	0,008	0,20574
6	6	0,192	4,877	22	22	0,029	0,726	38	38	0,008	0,2032
	1/4	0,188	4,775		1/4	0,028	0,709		1/4	0,008	0,20066
	1/2	0,185	4,699		1/2	0,027	0,691		1/2	0,008	0,198
	3/4	0,181	4,597		3/4	0,027	0,673		3/4	0,008	0,19304
7	7	0,177	4,496	23	23	0,026	0,655	39	39	0,008	0,1905
	1/4	0,173	4,394		1/4	0,025	0,638		1/4	0,007	0,18796
	1/2	0,170	4,318		1/2	0,024	0,620		1/2	0,007	0,185
	3/4	0,166	4,216		3/4	0,024	0,302		3/4	0,007	0,18034
8	8	0,162	4,115	24	24	0,023	0,584	40	40	0,007	0,1778
	1/4	0,159	4,039		1/4	0,022	0,569		1/4	0,007	0,17526
	1/2	0,155	3,937		1/2	0,022	0,551		1/2	0,007	0,175
	3/4	0,152	3,861		3/4	0,021	0,536		3/4	0,007	0,17018
9	9	0,148	3,767	25	25	0,020	0,516	41	41	0,007	0,16764
	1/4	0,145	3,683		1/4	0,020	0,503		1/4	0,007	0,16764
	1/2	0,142	3,607		1/2	0,019	0,490		1/2	0,006	0,163
	3/4	0,138	3,505		3/4	0,019	0,475		3/4	0,006	0,16002

## E Tabla de referencias cruzadas de cierres

## P Tabela de referência cruzada de encerramentos

## UK Fastener cross reference table

## F Matrice des fermetures

Grapas / Agrafos / Staples / Agrafes	ATRO	BEA	BOSTICH	DUO FAST	EDMA	HAUBOLD	KHILBERG	OMER	PASLODE	PREBENA	ROCAFIX	SENCO	SOFRAGRAF	VERTEX
3 Staples - 23 Gauge	-	-	-	-	-	-	-	62	-	-	-	B	-	-
G3 Staples - 22 Gauge	7	71	-	7	-	7100	670	3G	-	V	-	C	-	-
5 Staples - 20 Gauge	-	-	-	-	-	-	-	-	-	-	-	F	-	-
N5 Staples - 22 Gauge	-	-	-	-	-	-	-	-	-	-	-	E	-	-
75 Staples - 15 Gauge	-	-	-	-	-	-	-	-	-	-	-	J	-	-
80 Staple - 21 Gauge	8 (80)	80/380	86/AZ33	8600	-	800	680	80	-	A	-	AT	-	-
9 Staples	-	-	-	-	-	JK779	-	-	-	-	-	-	-	-
72 Staples - 23 Gauge	6 (63)	72	SB3020	30	-	1800	-	64	-	AB	-	-	-	-
STCR 2115	-	-	STCR 2115	-	-	-	-	-	-	-	-	-	-	-
STCR 5019	-	-	STCR 5019	-	-	-	-	-	-	-	-	-	-	-
53 Staples	-	-	-	-	-	-	-	-	-	-	-	-	-	-
88 Staples - 20 Gauge	88	-	-	-	-	-	-	88	-	-	-	-	-	-
1400 Staples - 23 Gauge	-	-	SP3020	-	-	1400	-	68	-	VF	-	-	-	-
4000 Staples - 21 Gauge	93	-	-	40	-	4000	690	40	-	TB	-	-	-	-
N3045 - 18 Gauge	-	-	-	-	-	-	-	-	-	-	-	K	-	-
N4450 - 18 Gauge	-	-	-	-	-	-	-	-	-	-	-	L	-	-
G4450 - 18 Gauge	-	-	-	-	-	-	-	-	-	-	-	M	-	-
94 Staples - 18 Gauge	94	94	-	-	-	-	-	94	-	AW	-	-	-	-
92 Staples - 18 Gauge	92	92-192	SL5035	-	-	-	664	92	-	H	-	-	-	-
97 (N7) Staples - 21 Gauge	-	97	SX4023	-	-	-	-	4097	-	O	-	W	-	-
98 Staples	98	98	98	-	-	-	-	98	-	HB	-	-	-	-
110 Staples	110	-	-	-	-	-	-	-	-	-	-	-	-	-
G5562 Staples - 16 Gauge	100	155	B100	-	-	-	783	M2	-	L	-	N	-	-
W5562 Staples - 16 Gauge	-	-	-	17	-	-	784	Wp	-	WS	-	P	-	-
G6774 Staples - 15 Gauge	-	180	-	-	-	HD7800	-	M3	-	Q	-	Q	-	-
S4 Staples - 16 Gauge	16NC	-	S4	-	-	-	-	S4	-	S	-	-	-	-
14 Staples - 17 Gauge	-	14	-	-	-	-	-	M1	-	LM	-	-	-	-
BCS31 Staples - 16 Gauge	-	-	BCS31	-	-	-	-	-	-	-	-	-	-	-
<b>Anillados / Anelados / Hog Rings</b>														
HR14 - 17 Gauge	-	-	-	-	-	-	-	-	-	-	-	-	HR14	-
HR16 - 17 Gauge	-	-	-	-	-	-	-	-	-	-	-	-	HR16	-
HR20 - 16 Gauge	-	-	-	-	-	-	-	-	-	-	-	-	HR20	-
HR22 - 15 Gauge	-	-	SR15	-	Delta 22	-	-	-	-	-	-	-	HR22	D ring
HR30 - 14 Gauge	-	-	-	-	-	-	-	-	-	-	-	-	HR30	-
RT (C) 23 - 15 Gauge	-	-	15100P	-	-	-	-	-	-	-	-	-	-	C ring
CL23 (1,6mm) - 16 Gauge	-	-	16G100	-	-	-	-	-	-	-	-	-	-	-
C20 - 16 Gauge	-	-	16G110	-	-	-	-	-	-	-	-	-	C20	-
CL12 - 16 Gauge	-	-	516G100	-	-	-	-	-	-	-	-	-	-	-
C17 - 16 Gauge	-	-	-	-	-	-	-	-	-	-	-	-	-	-
YK11 - 16 Gauge	-	-	-	-	-	-	-	-	-	-	-	-	-	-
CL - 45 11 Gauge	-	-	11G40	-	-	-	-	-	-	-	-	-	-	-
<b>Pins · Brad</b>														
Pin JSI - 23 Gauge	Mini	S700	-	-	-	ST06	506	Pin 0,6	-	AL	-	CZ	-	-
Pin 0,8 - 21 Gauge	Mini/S	-	MiniPin18	MP	-	ST08	-	-	-	BE	-	-	-	-
Pin LSI - 18 Gauge	I	I	AZ550	I	-	-	-	-	-	GA-Pins	-	AZ	-	-
Mini Brad - 21 Gauge	MiniTip	MiniTip	-	MB	-	-	-	Brads M	-	JA	-	-	-	-
Brad LSII - 18 Gauge	-	-	-	-	-	-	-	-	-	-	-	AY	-	-
Brad AX	TIPIN	TIPIN	BT1300	BT1300	-	SKN12	512	Brads 12	F18	JM	-	AX	-	-
Brad 1,53 - 16 Gauge	Tip	Tip	BT1200	BT1200	-	SKN16	516	Brad 14	F16	N	-	-	-	-
<b>Omega hog-rings</b>														
A16 - 14 Gauge	-	-	-	-	-	-	-	-	-	-	-	-	-	-
A18 - 14 Gauge	-	-	-	-	-	-	-	-	-	-	-	-	-	-
A18 Industrial - 14 Gauge	-	-	-	-	-	-	-	-	-	-	-	-	-	-
A20 - 14 Gauge	-	-	-	-	-	-	-	-	-	-	-	-	-	-
G30 - 14 Gauge	-	-	-	-	-	-	-	-	-	-	-	-	-	-
Omega 16 - 17 Gauge	-	-	-	-	Omega 16	-	-	-	-	-	-	VR16	-	-
Omega 20 - 14 Gauge	-	-	-	-	Omega 20	-	-	-	-	-	-	VR22	-	-
HR22 Fencing - 15 Gauge	-	-	-	-	Delta 22	-	-	-	-	-	-	HR22	-	-





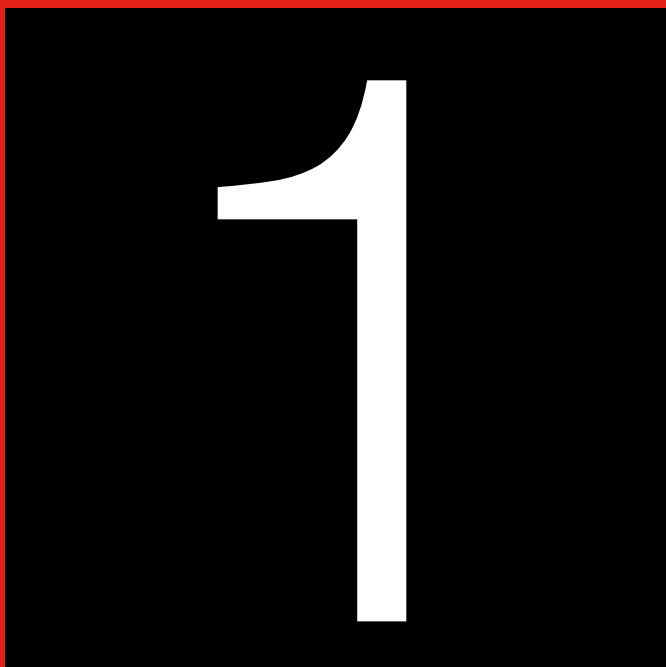

**GRAPAS**  
**AGRAFOS**  
**STAPLES**  
**AGRAFES**

mod 80	2
mod 3	3
mod G3 (71)	4
mod N3	5
mod 5	6
mod N5	7
mod 75	8
mod 97 (N7)	9
mod N3045	10
mod N4450 (90)	11
mod G4450	12
mod 92	13
mod G5562	14
mod S4	15
mod 14	16
mod W5562	17
mod G6774	18
mod RM (35)	19
mod Top	20
mod Arrow T-50	21
mod STCR2115	22
mod STCR5019	23
Chapa Corrugada	24
Semclamp	25
mod B6 / mod B10	26
Tacos 13	27
mod Roc77	28
mod 9	29
mod 110	29

Código	Modelo	Long. mm
Código	Modelo	Comp. mm
Code	Model	Length mm
Code	Modèle	Long. mm
4369504	80-4 T	4
4369506	80-6 T	6
4369508	80-8 T	8
4369510	80-10 T	10
4369512	80-12 T	12
4369514	80-14 T	14
4369516	80-16 T	16

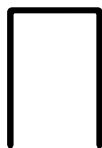

TAMAÑO REAL  
TAMANHO REAL  
ACTUAL SIZE  
TAILLE RÉELLE

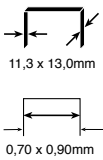

SENCO AT  
PREBENDA A  
KILHLBERG 680  
HAUBOLD 800  
DUO FAST 80  
BOSTITCH 86/AZ33  
BEA 80/38-ASTRO 8 (80)  
OMER 80

22  
GAUGE



# mod 80



TAPICERÍA  
ESTOFAMENTO  
UPHOLSTERY  
TAPISSERIE



PELETERÍA  
PELE  
FUR  
FOURRURE



CARPINTERÍA  
CARPINTARIA  
CARPENTRY  
MENUISERIE



EBANISTERIA Y MUEBLES  
MARÇENARIA E MÓVEIS  
JOINERY AND FURNITURE  
MENUISERIE ET MEUBLES



COLCHONERÍA  
COLCHÕES  
MATTRESSES  
MATELAS

- E** Recubrimiento del alambre: galvanizado.
- P** Revestimento de fio: galvanizado.
- UK** Wire coating: galvanized.
- F** Revêtement du fils: galvanisé.

## simG80

1205080

TIPO / TIPO / TYPE / TYPE

Neumática / Pneumática / Pneumatic / Pneumatique

GRAPA / AGRAFO / STAPLE / AGRAFE

80. 4-16 mm

PRESIÓN / PRESSÃO / PRESSURE / PRESSION

4 - 7 atm

PESO / PESO / WEIGHT / POIDS

0,9 Kg

CAPACIDAD / CAPACIDADE / CAPACITY / CAPACITÉ

157 grapas / agrafos / staples / agrafes



## Senco SFW FT10 AT-80

1050010

TIPO / TIPO / TYPE / TYPE

Neumática / Pneumática / Pneumatic / Pneumatique

GRAPA / AGRAFO / STAPLE / AGRAFE

80. 4-16 mm

PRESIÓN / PRESSÃO / PRESSURE / PRESSION

4 - 7 atm

PESO / PESO / WEIGHT / POIDS

0,9 Kg

CAPACIDAD / CAPACIDADE / CAPACITY / CAPACITÉ

160 grapas / agrafos / staples / agrafes



## Maestri ME-80

3810218

TIPO / TIPO / TYPE / TYPE

Eléctrica / Elétrica / Electric / Électrique

GRAPA / AGRAFO / STAPLE / AGRAFE

80. 4-16 mm

PESO / PESO / WEIGHT / POIDS

1,5 Kg

CAPACIDAD / CAPACIDADE / CAPACITY / CAPACITÉ

130 grapas / agrafos / staples / agrafes



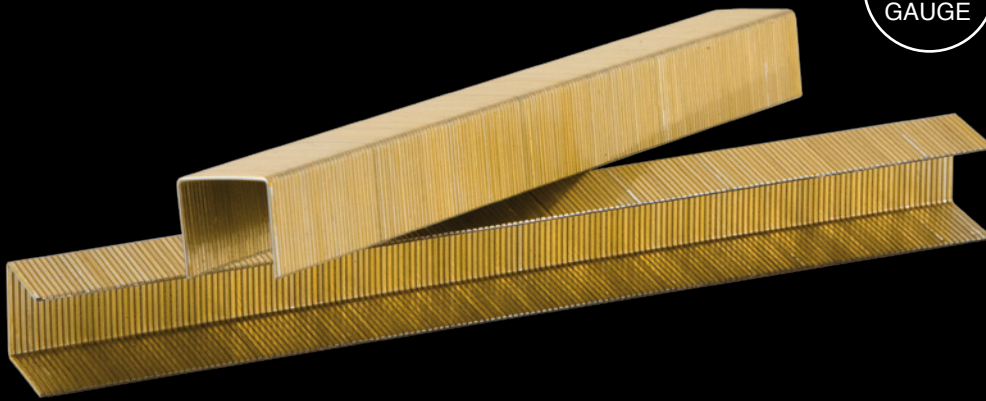

mod 3

Código Código Code Code	Modelo Modelo Model Modèle	Long. mm Comp. mm Length mm Long. mm
4020028	3-3	3
4020044	3-4	4
4020086	3-6	6
4020109	3-8	8
4020125	3-10	10
4020141	3-12	12
4020147	3-14	14

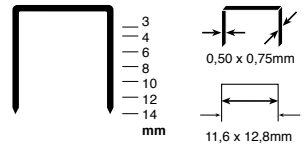

TAMAÑO REAL  
TAMANHO REAL  
ACTUAL SIZE  
TAILLE RÉELLE

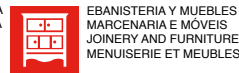
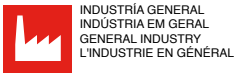

- E** Recubrimiento del alambre: galvanizado.
- P** Revestimento de fio: galvanizado.
- UK** Wire coating: galvanized.
- F** Revêtement du fils: galvanisé.

### Senco SFT10-B3

1050004

TIPO / TIPO / TYPE / TYPE  
Neumática / Pneumática / Pneumatic / Pneumatique

GRAPA / AGRAFO / STAPLE / AGRAFE  
3. 3-14 mm

PRESIÓN / PRESSÃO / PRESSURE / PRESSION  
4 - 7 atm

PESO / PESO / WEIGHT / POIDS  
0,9 Kg

CAPACIDAD / CAPACIDADE / CAPACITY / CAPACITÉ  
160 grapas / agrafos / staples / agrafes

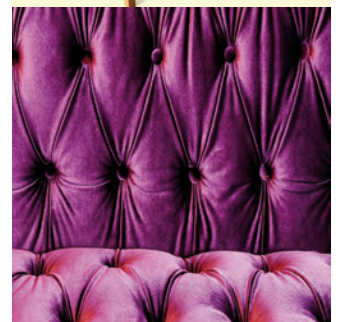

Código	Modelo	Long. mm
Código	Modelo	Comp. mm
Code	Model	Length mm
Code	Modèle	Long. mm
4060020	G3-3	3
4060046	G3-4	4
4060062	G3-6	6
4060088	G3-8	8
4060101	G3-10	10
4060127	G3-12	12
4060145	G3-14	14
4060169	G3-16	16
4060143	G3-14 (P)	14
4060172	G3-16 (P)	16
4066705	G3-10 PD GALV.	10
4066707	G3-12 PD GALV.	12
4066750	G3-14 PD GALV.	14
4066804	G3-16 PD GALV.	16

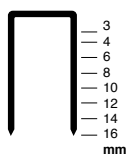

TAMAÑO REAL  
TAMANHO REAL  
ACTUAL SIZE  
TAILLE RÉELLE

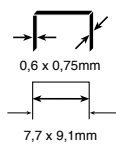

SENCO C  
PREBENDA V  
KIHLBERG 670  
HAUBOLD 710  
DUO FAST 7  
BEA 71  
ATRO 7  
OMER 3G

22  
GAUGE

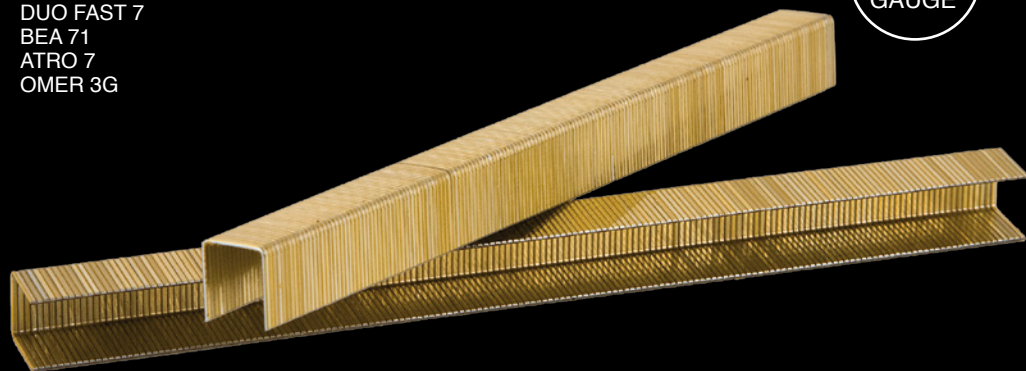

# mod G3 (71)



TAPICERÍA  
ESTOFAMENTO  
UPHOLSTERY  
TAPISSERIE



PELETERÍA  
PELE  
FUR  
FOURRURE



EBANISTERÍA Y MUEBLES  
MARCENARIA E MÓVEIS  
JOINERY AND FURNITURE  
MENUISERIE ET MEUBLES



COLCHONERÍA  
COLCHÕES  
MATTRESSES  
MATELAS

- E** Recubrimiento del alambre: galvanizado color oro, galvanizado.  
PD (Punta divergente) / P (Peletería)
- P** Revestimento de fio: ouro galvanizado, galvanizado.  
PD (Ponto divergente) / P (Pele)
- UK** Wire coating: galvanized gold, galvanized.  
PD (Divergent point) / P (Fur)
- F** Revêtement du fils: galvanisé doré, galvanisé.  
PD (Pointe divergente) / P (Fourrure)

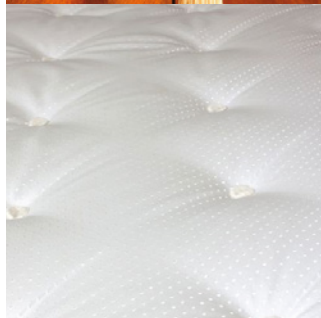

## simG71

1205071

TIPO / TIPO / TYPE / TYPE

Neumática / Pneumática / Pneumatic / Pneumatique

GRAPA / AGRAFO / STAPLE / AGRAFE  
G3 (71). 3-14 mm

PRESIÓN / PRESSÃO / PRESSURE / PRESSION  
4 - 7 atm

PESO / PESO / WEIGHT / POIDS  
0,8 Kg

CAPACIDAD / CAPACIDADE / CAPACITY / CAPACITÉ  
185 grapas / agrafos / staples / agrafes





# mod N3



TAPICERÍA  
ESTOFAMIENTO  
UPHOLSTERY  
TAPISSERIE



PELETERÍA  
PELE  
FUR  
FOURRURE



CALZADO  
CALÇADOS  
FOOTWEAR  
CHAUSSURES



EMBALAJE MADERA  
EMBALAGEM DE MADEIRA  
CRATES  
EMBALLAGE EN BOIS



ATAUDES  
CAIXÕES  
COFFINS  
CERCUEILS

- E** Recubrimiento del alambre: galvanizado.
- P** Revestimento de fio: galvanizado.
- UK** Wire coating: galvanized.
- F** Revêtement du fils: galvanisé.

## Senco Proserie SFW10A-N3

1060866

TIPO / TIPO / TYPE / TYPE

Neumática / Pneumática / Pneumatic / Pneumatique

GRAPA / AGRAFO / STAPLE / AGRAFE

N3. 14 -16 mm

PRESIÓN / PRESSÃO / PRESSURE / PRESSION

4 - 7 atm

PESO / PESO / WEIGHT / POIDS

0,9 Kg

CAPACIDAD / CAPACIDADE / CAPACITY / CAPACITÉ

110 grapas / agrafos / staples / agrafes

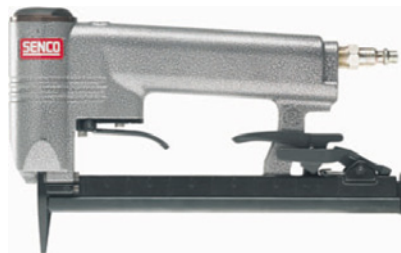

Código Código Code Code	Modelo Modelo Model Modèle	Long. mm Comp. mm Length mm Long. mm
4040273	N3-4	4
4040312	N3-6	6
4040338	N3-8	8
4040354	N3-10	10
4040370	N3-12	12
4040383	N3-14	14
4040396	N3-16	16
4046060	N3-6 PD	6
4047049	N3-8 PD	8
4047051	N3-10 PD	10

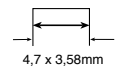
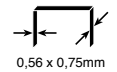
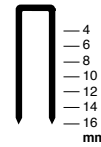

TAMAÑO REAL  
TAMANHO REAL  
ACTUAL SIZE  
TAILLE RÉELLE

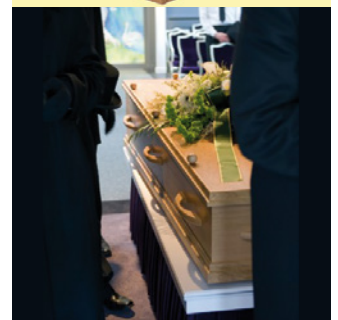

Código	Modelo	Long. mm
Código	Modelo	Comp. mm
Code	Model	Length mm
Code	Modèle	Long. mm
4080275	5-3	3
4080314	5-6	6
4080330	5-8	8
4080356	5-10	10
4080372	5-12	12

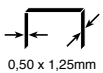
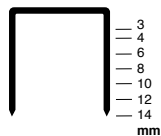

TAMAÑO REAL  
TAMANHO REAL  
ACTUAL SIZE  
TAILLE RÉELLE

SENCOS F

 20  
GAUGE

# mod 5

 CALZADO  
CALÇADOS  
FOOTWEAR  
CHAUSSURES

 PELETERÍA  
PELE  
FUR  
FOURRURE

 EMBALAJE MADERA  
EMBALAGEM DE MADEIRA  
CRATES  
EMBALLAGE EN BOIS

 INDUSTRIA AUTOMÓVIL  
INDÚSTRIA AUTOMÓVEL  
AUTOMOTIVE INDUSTRY  
INDUSTRIE AUTOMOBILE

 EBANISTERIA Y MUEBLES  
MARCENARIA E MOVEIS  
JOINERY AND FURNITURE  
MENUISERIE ET MEUBLES

 EMBALAJE CARTÓN  
EMBALAGEM DE PAPELÃO  
CARDBOARD PACKAGING  
EMBALLAGE EN CARTON

**E** Recubrimiento del alambre: galvanizado.

**P** Revestimento de fio: galvanizado.

**UK** Wire coating: galvanized.

**F** Revêtement du fils: galvanisé.

## Senco SFW FT 10-F-5

1060650

TIPO / TIPO / TYPE / TYPE

Neumática / Pneumática / Pneumatic / Pneumatique

GRAPA / AGRAFO / STAPLE / AGRAFE

5. 3-12 mm

PRESIÓN / PRESSÃO / PRESSURE / PRESSION

4 - 7 atm

PESO / PESO / WEIGHT / POIDS

0,9 Kg

CAPACIDAD / CAPACIDADE / CAPACITY / CAPACITÉ

120 grapas / agrafos / staples / agrafes

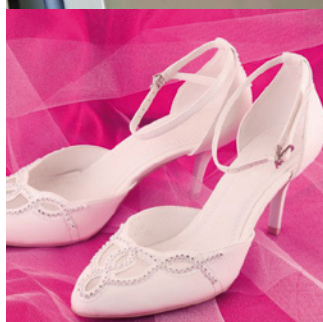
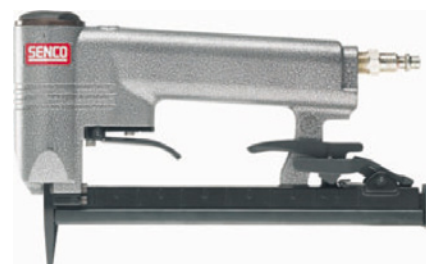

## Especial 71

3100088

TIPO / TIPO / TYPE / TYPE

Neumática / Pneumática

Pneumatic / Pneumatique

GRAPA / AGRAFO / STAPLE / AGRAFE

5. 4-12 mm

PRESIÓN / PRESSÃO

PRESSURE / PRESSION

4 - 7 atm



## Especial 75

3100172

TIPO / TIPO / TYPE / TYPE

Neumática / Pneumática

Pneumatic / Pneumatique

GRAPA / AGRAFO / STAPLE / AGRAFE

5. 4-12 mm

PRESIÓN / PRESSÃO

PRESSURE / PRESSION

4 - 7 atm



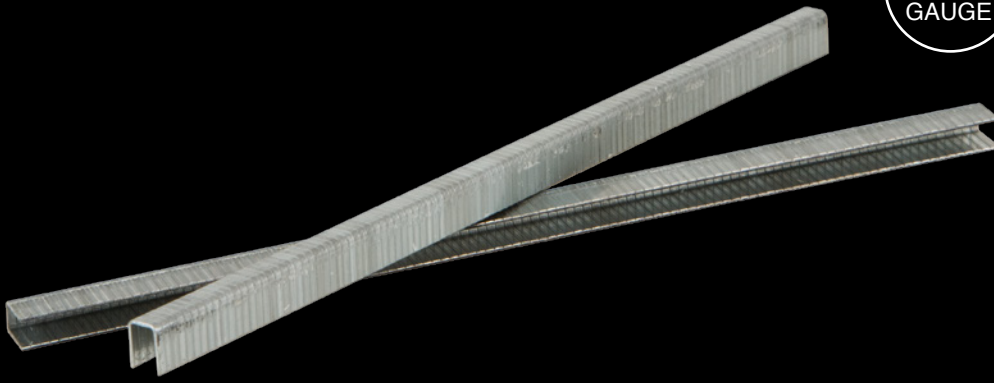

# mod N5

Código Código Code Code	Modelo Modelo Model Modèle	Long. mm Comp. mm Length mm Long. mm
4100278	N5-4	4
4100317	N5-6	6
4100333	N5-8	8
4100359	N5-10	10
4100375	N5-12	12
4100391	N5-14	14
4100414	N5-16	16

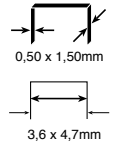
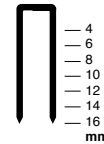

TAMAÑO REAL  
TAMANHO REAL  
ACTUAL SIZE  
TAILLE RÉELLE



CALZADO  
CALÇADOS  
FOOTWEAR  
CHAUSSURES



EMBALAJE MADERA  
EMBALAGEM DE MADEIRA  
CRATES  
EMBALLAGE EN BOIS



INDUSTRIA AUTOMÓVIL  
INDÚSTRIA AUTOMÓVEL  
AUTOMOTIVE INDUSTRY  
INDUSTRIE AUTOMOBILE



EBANISTERIA Y MUEBLES  
MARCENARIA E MÓVEIS  
JOINERY AND FURNITURE  
MENUISERIE ET MEUBLES

- E** Recubrimiento del alambre: básico.
- P** Revestimento de fio: básico.
- UK** Wire coating: basic.
- F** Revêtement de fil: basique.

## Senco SFW FT 10-E-N5

1060916

TIPO / TIPO / TYPE / TYPE  
Neumática / Pneumática / Pneumatic / Pneumatique  
GRAPA / AGRAFO / STAPLE / AGRAFE  
N5. 4-16 mm

PRESIÓN / PRESSÃO / PRESSURE / PRESSION  
4 - 7 atm

PESO / PESO / WEIGHT / POIDS  
0,9 Kg

CAPACIDAD / CAPACIDADE / CAPACITY / CAPACITÉ  
120 grapas / agrafos / staples / agrafes

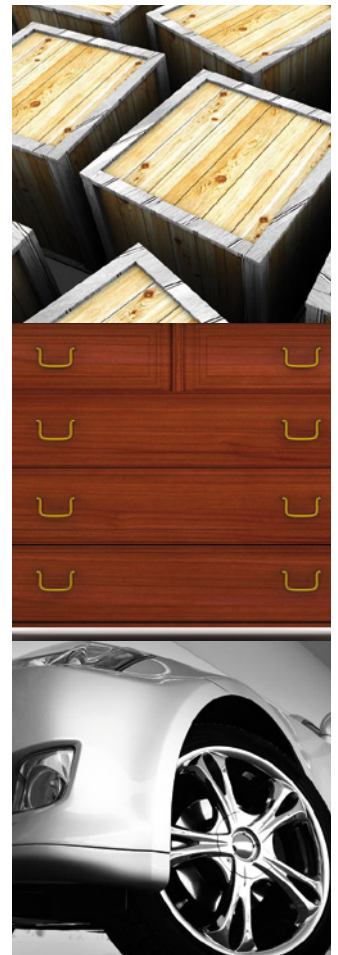

1

**GRAPAS  
AGRAFOS  
STAPLES  
AGRAFES**

Código	Modelo	Long. mm
Código	Modelo	Comp. mm
Code	Model	Length mm
Code	Modèle	Long. mm
4120287	75-8	8
4120300	75-10	10
4120326	75-12	12
4120342	75-16	16
4120347	75-20	20

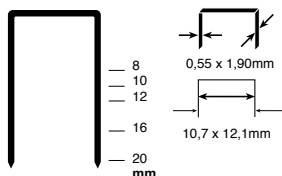

TAMAÑO REAL  
TAMANHO REAL  
ACTUAL SIZE  
TAILLE RÉELLE

SENCO J

15  
GAUGE

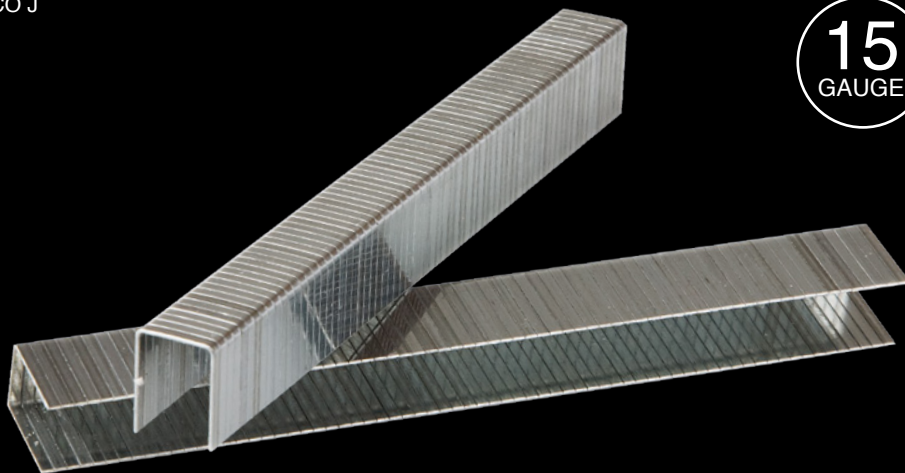

# mod 75



EMBALAJE CARTÓN  
EMBALAGEM DE PAPELÃO  
CARDBOARD PACKAGING  
EMBALLAGE EN CARTON



COLCHONERÍA  
COLCHÕES  
MATTRESSES  
MATELAS

- E** Recubrimiento del alambre: galvanizado.
- P** Revestimento de fio: galvanizado.
- UK** Wire coating: galvanized.
- F** Revêtement du fils: galvanisé.

## Senco Mod. F 75-2"

1040030

TIPO / TIPO / TYPE / TYPE

Neumática / Pneumática / Pneumatic / Pneumatique

GRAPA / AGRAFO / STAPLE / AGRAFE

75. 8-16 mm

PRESIÓN / PRESSÃO / PRESSURE / PRESSION

4 - 7 atm

PESO / PESO / WEIGHT / POIDS

2 Kg

CAPACIDAD / CAPACIDADE / CAPACITY / CAPACITÉ

112 grapas / agrafos / staples / agrafes



## Senco Mod. F 75-LR

1040098

TIPO / TIPO / TYPE / TYPE

Neumática / Pneumática / Pneumatic / Pneumatique

GRAPA / AGRAFO / STAPLE / AGRAFE

75. 8-16 mm

PRESIÓN / PRESSÃO / PRESSURE / PRESSION

4 - 7 atm

PESO / PESO / WEIGHT / POIDS

2 Kg

CAPACIDAD / CAPACIDADE / CAPACITY / CAPACITÉ

112 grapas / agrafos / staples / agrafes





SENCO W  
PREBENA O  
BOSTITCH SX4023  
BEA 97  
OMER 4097

21  
GAUGE



mod 97 (N7)



TAPICERÍA  
ESTOFAMENTO  
UPHOLSTERY  
TAPISSERIE

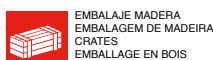

EMBALAJE MADERA  
EMBALAGEM DE MADEIRA  
CRATES  
EMBALLAGE EN BOIS



CARPINTERÍA  
CARPINTARIA  
CARPENTRY  
MENUISERIE

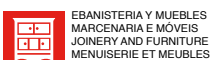

EBANISTERIA Y MUEBLES  
MARCEINARIA E MOVEIS  
JOINERY AND FURNITURE  
MENUISERIE ET MEUBLES



CALZADO  
CALÇADOS  
FOOTWEAR  
CHAUSSURES

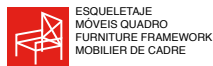

ESQUELETAJE  
MOVEIS QUADRO  
FURNITURE FRAMEWORK  
MOBILIER DE CADRE



INDUSTRIA GENERAL  
INDÚSTRIA EM GERAL  
GENERAL INDUSTRY  
L'INDUSTRIE EN GENERAL

- E** Recubrimiento del alambre: galvanizado.
- P** Revestimento de fio: galvanizado.
- UK** Wire coating: galvanized.
- F** Revêtement du fils: galvanisé.

## simG97

1205097

TIPO / TIPO / TYPE / TYPE

Neumática / Pneumática / Pneumatic / Pneumatique

GRAPA / AGRAFO / STAPLE / AGRAFE

97. 6-25 mm

PRESIÓN / PRESSÃO / PRESSURE / PRESSION

4 - 7 atm

PESO / PESO / WEIGHT / POIDS

1,2 Kg

CAPACIDAD / CAPACIDADE / CAPACITY / CAPACITÉ

142 grapas / agrafos / staples / agrafes



GRAPAS  
AGRAFOS  
STAPLES  
AGRAFES

1

Código Código Code Code	Modelo Modelo Model Modèle	Long. mm Comp. mm Length mm Long. mm
4490906	N7-6	6
4490908	N7-8	8
4490910	N7-10	10
4490912	N7-12	12
4490714	N7-14	14
4490716	N7-16	16
4490670	N7-19	19
4490675	N7-22	22
4490680	N7-25	25



6  
8  
10  
12  
14  
16  
19  
20  
22  
25  
mm

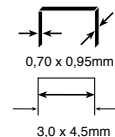

TAMAÑO REAL  
TAMANHO REAL  
ACTUAL SIZE  
TAILLE RÉELLE

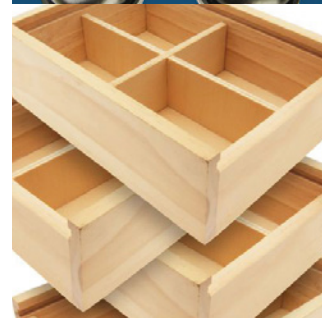

Código	Modelo	Long. mm
Código	Modelo	Comp. mm
Code	Model	Length mm
Code	Modèle	Long. mm
4140063	N3045-10	10
4140089	N3045-12	12
4140102	N3045-14	14
4140128	N3045-16	16
4140144	N3045-20	20
4140160	N3045-23	23
4140186	N3045-25	25

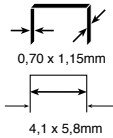
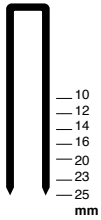

TAMAÑO REAL  
TAMANHO REAL  
ACTUAL SIZE  
TAILLE RÉELLE

SENCO K

**18**  
GAUGE

# mod N3045



CONSTRUCCIÓN  
CONSTRUÇÃO  
CONSTRUCTION  
CONSTRUCTION



EMBALAJE MADERA  
EMBALAGEM DE MADEIRA  
CRATES  
EMBALLAGE EN BOIS



CARPINTERÍA  
CARPINTARIA  
CARPENTRY  
MENUISERIE



EBANISTERIA Y ML.  
MARCENARIA E MC  
JOINERY AND FURNI  
MENUISERIE ET ME

- E** Recubrimiento del alambre: básico.
- P** Revestimiento de fio: básico.
- UK** Wire coating: basic.
- F** Revêtement de fil: basique.

## Senco SLS-K

**1080061**

TIPO / TIPO / TYPE / TYPE

Neumática / Pneumática / Pneumatic / Pneumatique

GRAPA / AGRAFO / STAPLE / AGRAFE

N3045. 10-25 mm

PRESIÓN / PRESSÃO / PRESSURE / PRESSION

4 - 7 atm

PESO / PESO / WEIGHT / POIDS

1,13 Kg

CAPACIDAD / CAPACIDADE / CAPACITY / CAPACITÉ

168 grapas / agrafos / staples / agrafes

**SENCO**



18  
GAUGE

GRAPAS  
AGRAFOS  
STAPLES  
AGRAFES

1

# mod N4450 (90)

Código Código Code Code	Modelo Modelo Model Modèle	Long. mm Comp. mm Length mm Long. mm
4160069	N4450-10	10
4160072	N4450-12	12
4160086	N4450-14	14
4160098	N4450-16	16
4160111	N4450-20	20
4160137	N4450-23	23
4160140	N4450-25	25
4160166	N4450-28	28
4160179	N4450-30	30
4160182	N4450-32	32
4160205	N4450-35	35
4160221	N4450-37	37
4160240	N4450-40	40



TAPICERÍA  
ESTOFAMIENTO  
UPHOLSTERY  
TAPISSERIE



EBANISTERIA Y MUEBLES  
MARCENARIA E MÓVEIS  
JOINERY AND FURNITURE  
MENUISERIE ET MEUBLES



CONSTRUCCIÓN  
CONSTRUÇÃO  
CONSTRUCTION  
CONSTRUCTION



ESQUELETAJE  
MÓVEIS QUADRO  
FURNITURE FRAMEWORK  
MOBILIER DE CADRE



INDUSTRIA GENERAL  
INDUSTRIA EM GERAL  
GENERAL INDUSTRY  
L'INDUSTRIE EN GÉNÉRAL

- E** Recubrimiento del alambre: básico, galvanizado.
- P** Revestimento de fio: básico, galvanizado.
- UK** Wire coating: basic, galvanized.
- F** Revêtement de fil: base, galvanisé.

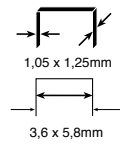

TAMAÑO REAL  
TAMANHO REAL  
ACTUAL SIZE  
TAILLE RÉELLE

## Senco SLS-20L

1080130

TIPO / TIPO / TYPE / TYPE  
Neumática / Pneumática / Pneumatic / Pneumatique  
GRAPA / AGRAFO / STAPLE / AGRAFE  
4450. 12-25 mm

PRESIÓN / PRESSÃO / PRESSURE / PRESSION  
4 - 7 atm

PESO / PESO / WEIGHT / POIDS  
1,21 Kg

CAPACIDAD / CAPACIDADE / CAPACITY / CAPACITÉ  
168 grapas / agrafos / staples / agrafes



## Senco SKS-L N4450

1100325

TIPO / TIPO / TYPE / TYPE  
Neumática / Pneumática / Pneumatic / Pneumatique  
GRAPA / AGRAFO / STAPLE / AGRAFE  
4450. 12-25 mm

PRESIÓN / PRESSÃO / PRESSURE / PRESSION  
4 - 7 atm

PESO / PESO / WEIGHT / POIDS  
1,9 Kg

CAPACIDAD / CAPACIDADE / CAPACITY / CAPACITÉ  
145 grapas / agrafos / staples / agrafes

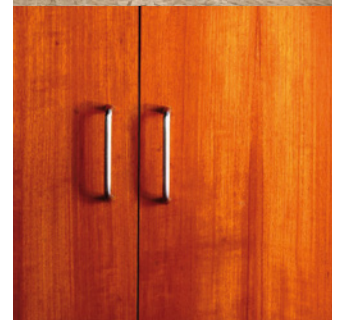

1

**GRAPAS  
AGRAFOS  
STAPLES  
AGRAFES**

Código	Modelo	Long. mm
Código	Modelo	Comp. mm
Code	Model	Length mm
Code	Modèle	Long. mm
4180023	G4450-10	10
4180049	G4450-12	12
4180065	G4450-16	16
4180081	G4450-20	20
4180104	G4450-23	23
4180120	G4450-25	25
4180146	G4450-30	30
4180162	G4450-32	32
4180390	G4450-35	35
4180201	G4450-37	37

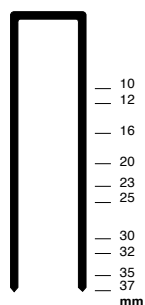

TAMAÑO REAL  
TAMANHO REAL  
ACTUAL SIZE  
TAILLE RÉELLE

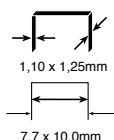

SENCO M

**18**  
GAUGE

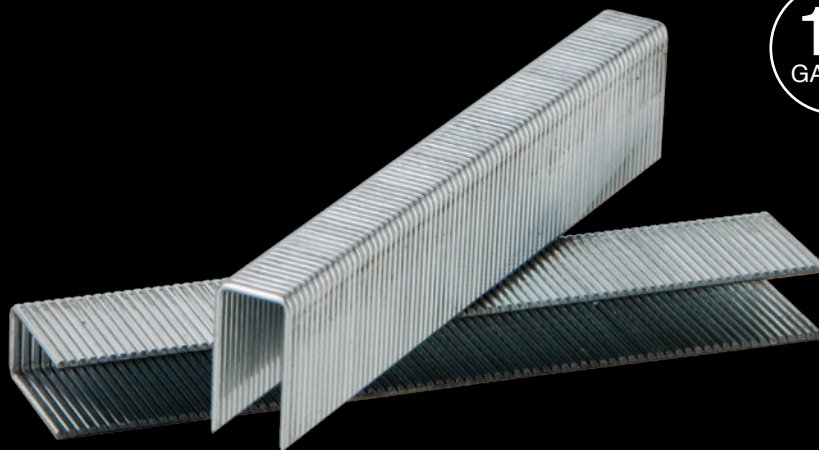

# mod G4450



TAPICERÍA  
ESTOFAMENTO  
UPHOLSTERY  
TAPISSERIE



CARPINTERÍA  
CARPINTARIA  
CARPENTRY  
MENUISERIE



EBANISTERÍA Y MUEBLES  
MARCENARIA E MÓVEIS  
JOINERY AND FURNITURE  
MENUISERIE ET MEUBLES



COLCHONERÍA  
COLCHÕES  
MATTRESSES  
MATELAS

- E** Recubrimiento del alambre: galvanizado.
- P** Revestimento de fio: galvanizado.
- UK** Wire coating: galvanized.
- F** Revêtement de fil: galvanisé.

## simG4450

1205150

TIPO / TIPO / TYPE / TYPE

Neumática / Pneumática / Pneumatic / Pneumatique

GRAPA / AGRAFO / STAPLE / AGRAFE

G4450. 10-25 mm

PRESIÓN / PRESSÃO / PRESSURE / PRESSION

5 - 8 atm

PESO / PESO / WEIGHT / POIDS

1,3 Kg

CAPACIDAD / CAPACIDADE / CAPACITY / CAPACITÉ

100 grapas / agrafos / staples / agrafes

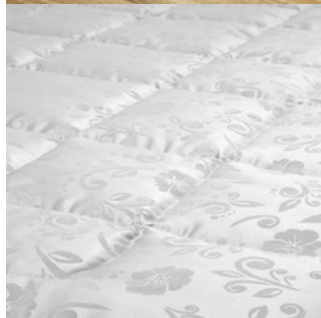
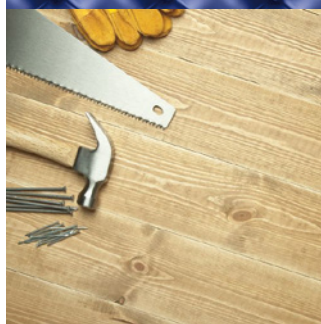
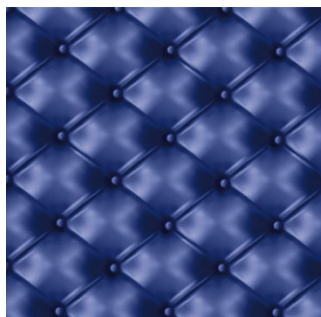

PREBENA H  
 KIHBERG 664  
 BOSTITCH SL5035  
 BEA 92-192  
 OMER 92  
 ATRO 92

18  
 GAUGE

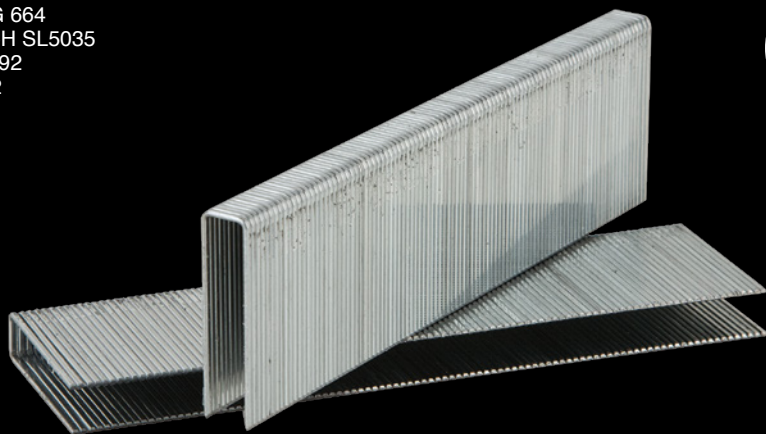

# mod 92

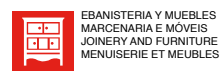

- E** Recubrimiento del alambre: galvanizado.
- P** Revestimento de fio: galvanizado.
- UK** Wire coating: galvanized.
- F** Revêtement de fil: galvanisé.

## simG92

1205092

TIPO / TIPO / TYPE / TYPE

Neumática / Pneumática / Pneumatic / Pneumatique

GRAPA / AGRAFO / STAPLE / AGRAFE

92. 16-40 mm

PRESIÓN / PRESSÃO / PRESSURE / PRESSION

5 - 8 atm

PESO / PESO / WEIGHT / POIDS

1,9 Kg

CAPACIDAD / CAPACIDADE / CAPACITY / CAPACITÉ

160 grapas / agrafos / staples / agrafes



GRAPAS  
 AGRAFOS  
 STAPLES  
 AGRAFES

1

Código	Modelo	Long. mm
Código	Modelo	Comp. mm
Code	Model	Length mm
Code	Modèle	Long. mm
4490712	92-12	12
4490715	92-15	15
4490720	92-20	20
4490725	92-25	25
4490730	92-30	30
4490735	92-35	35
4490740	92-40	40

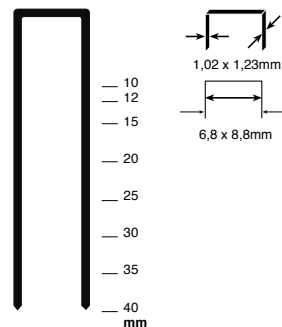

TAMAÑO REAL  
 TAMANHO REAL  
 ACTUAL SIZE  
 TAILLE RÉELLE

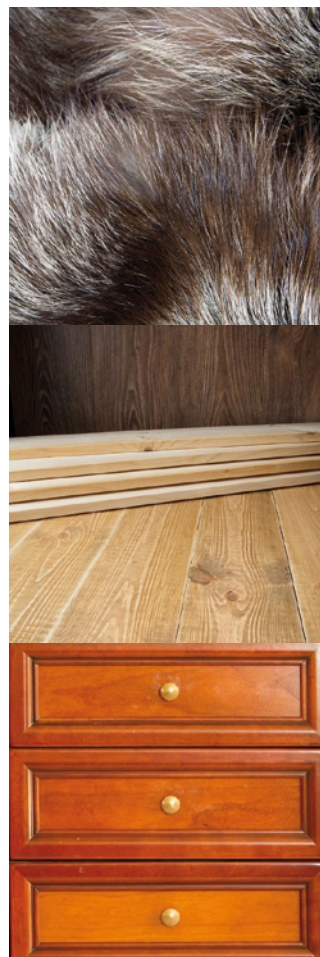

Código	Modelo	Long. mm
Código	Modelo	Comp. mm
Code	Model	Length mm
Code	Modèle	Long. mm
4200042	G5562-12	12
4200068	G5562-16	16
4200084	G5562-20	20
4200107	G5562-23	23
4200110	G5562-25	25
4200120	G5562-28	28
4200136	G5562-30	30
4200149	G5562-32	32
4200165	G5562-35	35
4200178	G5562-38	38
4200194	G5562-40	40
4200217	G5562-45	45
4200233	G5562-50	50

PUNTA DIVERGENTE / PONTO DIVERGENTE  
DIVERGENT POINT / POINTE DIVERGENTE

4209506	G5562-16 PD	16
4209512	G5562-20 PD	20
4209515	G5562-23 PD	23
4206101	G5562-25 PD	25
4206130	G5562-30 PD	30
4206143	G5562-32 PD	32
4206169	G5562-35 PD	35
4206172	G5562-40 PD	40
4206171	G5562-45 PD	45
4206170	G5562-50 PD	50

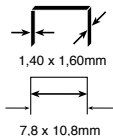
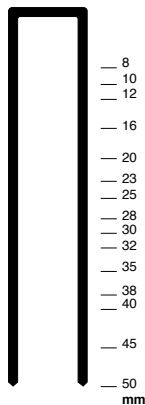

TAMAÑO REAL  
TAMANHO REAL  
ACTUAL SIZE  
TAILLE RÉELLE



SENCO N  
PREBENA L  
KIHLBERG 783  
BOSTITCH B100  
BEA 155  
ATRO 100  
OMER M2

16  
GAUGE



# mod G5562



TAPICERÍA  
ESTOFAMEN TO  
UPHOLSTERY  
TAPISSERIE



ESQUELETAJE  
MÓVEIS QUADRO  
FURNITURE FRAMEWORK  
MOBILIER DE CADRE



CARPINTERÍA  
CARPINTARIA  
CARPENTRY  
MENUISERIE



EBANISTERIA Y MUEBLES  
MARCENARIA E MÓVEIS  
JOINERY AND FURNITURE  
MENUISERIE ET MEUBLES



CONSTRUCCIÓN  
CONSTRUÇÃO  
CONSTRUCTION  
CONSTRUCTION



PALETS  
PALLETTS  
PALETTS  
PALETTES

- E** Recubrimiento del alambre: básico.
- P** Revestimento de fio: básico.
- UK** Wire coating: basic.
- F** Revêtement de fil: basique.

## simG5562

1205162

TIPO / TIPO / TYPE / TYPE

Neumática / Pneumática / Pneumatic / Pneumatique

GRAPA / AGRAFO / STAPLE / AGRAFE  
G5562 (14). 25-50 mm

PRESIÓN / PRESSÃO / PRESSURE / PRESSION  
5 - 8 atm

PESO / PESO / WEIGHT / POIDS  
1,94 Kg

CAPACIDAD / CAPACIDADE / CAPACITY / CAPACITÉ  
140 grapas / agrafos / staples / agrafes



## Senco SNS 45XP

1120030

TIPO / TIPO / TYPE / TYPE

Neumática / Pneumática / Pneumatic / Pneumatique

GRAPA / AGRAFO / STAPLE / AGRAFE  
G5562 (14). 25-50 mm

PRESIÓN / PRESSÃO / PRESSURE / PRESSION  
5 - 8 atm

PESO / PESO / WEIGHT / POIDS  
2,3 Kg

CAPACIDAD / CAPACIDADE / CAPACITY / CAPACITÉ  
160 grapas / agrafos / staples / agrafes



PREBENA WS  
BOSTITCH S4  
ATRO 16NC  
OMER S4

16  
GAUGE

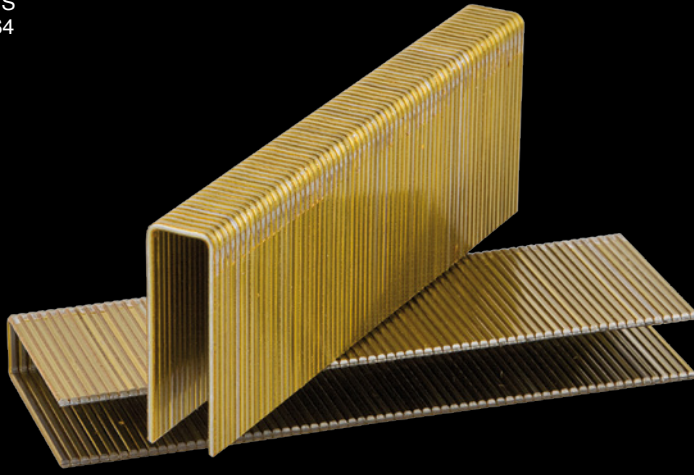

# mod S4



EBANISTERIA Y MUEBLES  
MARCENARIA E MÓVEIS  
JOINERY AND FURNITURE  
MENUISERIE ET MEUBLES



COLCHONERÍA  
COLCHÕES  
MATTRESSES  
MATELAS



ESQUELETAJE  
MÓVEIS QUADRO  
FURNITURE FRAMEWORK  
MOBILIER DE CADRE



PALETS  
PALLETES  
PALETES  
PALETES



TAPICERÍA  
ESTOFAMENTO  
UPHOLSTERY  
TAPESSERIE

- E** Recubrimiento del alambre: básico brillante.
- P** Revestimento de fio: básico brilhante.
- UK** Wire coating: basic bright.
- F** Revêtement de fil: basique brillant.

GRAPAS  
AGRAFOS  
STAPLES  
AGRAFES

1

Código Código Code Code	Modelo Modelo Model Modèle	Long. mm Comp. mm Length mm Long. mm
4355430	S4-30	30
4355432	S4-32	32
4355435	S4-35	35
4355438	S4-38	38
4355440	S4-40	40
4355445	S4-45	45
4355450	S4-50	50

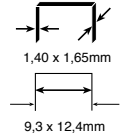

TAMAÑO REAL  
TAMANHO REAL  
ACTUAL SIZE  
TAILLE RÉELLE



1

**GRAPAS  
AGRAFOS  
STAPLES  
AGRAFES**

Código	Modelo	Long. mm
Código	Modelo	Comp. mm
Code	Model	Length mm
Code	Modèle	Long. mm
4200005	14-20	20
4200010	14-25	25
4200013	14-30	30
4200016	14-35	35
4200018	14-40	40
4200020	14-45	45
4200023	14-50	50

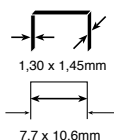
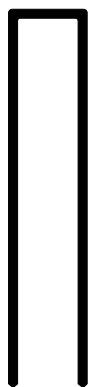

— 20  
— 25  
— 30  
— 35  
— 40  
— 45  
— 50  
mm

TAMAÑO REAL  
TAMANHO REAL  
ACTUAL SIZE  
TAILLE RÉELLE

PREBENA LM  
BEA 14  
OMER M1

17  
GAUGE

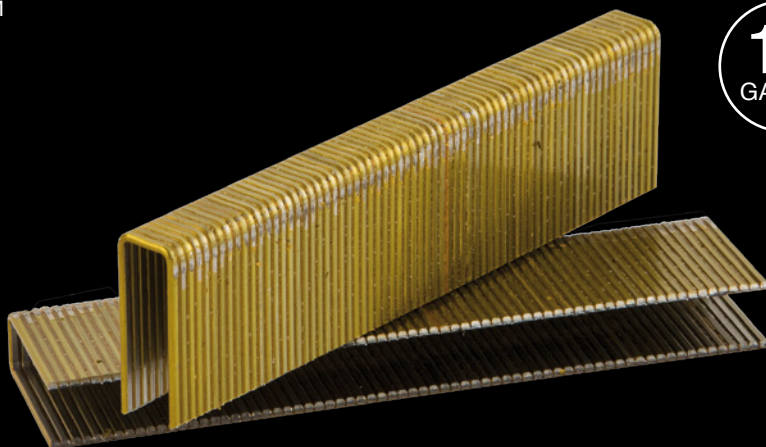

# mod 14



EBANISTERIA Y MUEBLES  
MARCENARIA E MÓVEIS  
JOINERY AND FURNITURE  
MENUISERIE ET MEUBLES



COLCHONERÍA  
COLCHÕES  
MATTRESSES  
MATELAS



ESQUELETAJE  
MÓVEIS QUADRO  
FURNITURE FRAMEWORK  
MOBILIER DE CADRE



PALETS  
PALLETES  
PALETES  
PALETTES



TAPICERÍA  
ESTOFAMENTO  
UPHOLSTERY  
TAPISSERIE

- E** Recubrimiento del alambre: básico brillante.
- P** Revestimento de fio: básico brilhante.
- UK** Wire coating: basic bright.
- F** Revêtement de fil: basique brillant.

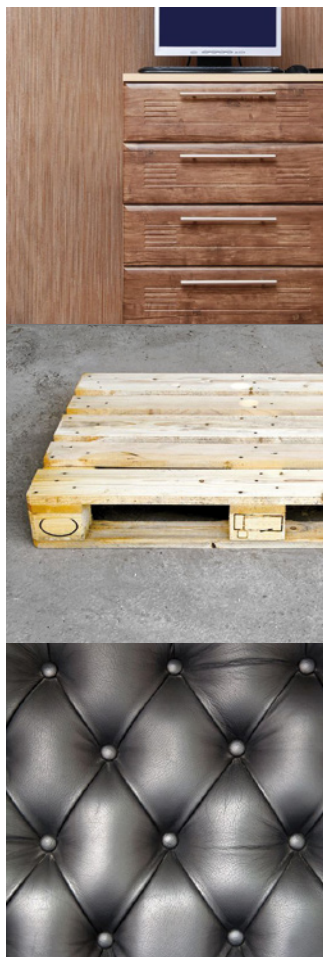



SECO P  
PREBENA WS  
KIHLBERG 784  
DUOFAS 17  
OMER WP

16  
GAUGE

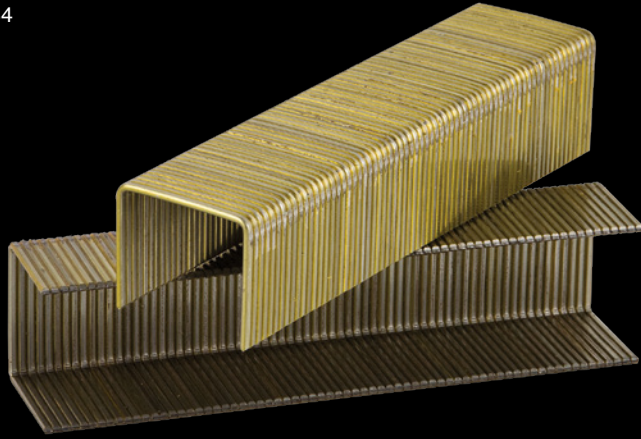

# mod W5562



EMBALAJE MADERA  
EMBALAGEM DE MADEIRA  
CRATES  
EMBALLAGE EN BOIS



PALETS  
PALETS  
PALETTES  
PALETTES



INDUSTRIA GENERAL  
INDUSTRIA EM GERAL  
GENERAL INDUSTRY  
L'INDUSTRIE EN GENERAL



CONSTRUÇÃO  
CONSTRUÇÃO  
CONSTRUCTION  
CONSTRUCTION

- E** Recubrimiento del alambre: básico.
- P** Revestimento de fio: básico.
- UK** Wire coating: basic.
- F** Revêtement de fil: basique.

## simW5562

1205362

TIPO / TIPO / TYPE / TYPE

Neumática / Pneumática / Pneumatic / Pneumatique

GRAPA / AGRAFO / STAPLE / AGRAFE

W5562. 25-50 mm

PRESIÓN / PRESSÃO / PRESSURE / PRESSION

5 - 8 atm

PESO / PESO / WEIGHT / POIDS

3,0 Kg

CAPACIDAD / CAPACIDADE / CAPACITY / CAPACITÉ

140 grapas / agrafos / staples / agrafes

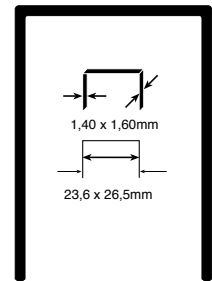

TAMAÑO REAL  
TAMANHO REAL  
ACTUAL SIZE  
TAILLE RÉELLE

— 12  
— 16  
— 20  
— 23  
— 25  
— 28  
— 30  
— 32  
— 35  
— 37  
mm

GRAPAS  
AGRAFOS  
STAPLES  
AGRAFES

1

Código Código Code Code	Modelo Modelo Model Modèle	Long. mm Comp. mm Length mm Long. mm
4220022	W5562-12	12
4220048	W5562-16	16
4220064	W5562-20	20
4220080	W5562-23	23
4220103	W5562-25	25
4220145	W5562-30	30
4220161	W5562-32	32
4220187	W5562-35	35
4220200	W5562-37	37

PUNTA DIVERGENTE / PONTO DIVERGENTE  
DIVERGENT POINT / POINTE DIVERGENTE

4226068	W5562-20 PD	20
4226069	W5562-23 PD	23
4226070	W5562-25 PD	25
4226072	W5562-27 PD	27
4226075	W5562-30 PD	30



# 1

**GRAPAS  
AGRAFOS  
STAPLES  
AGRAFES**

Código	Modelo	Long. mm
Código	Modelo	Comp. mm
Code	Model	Length mm
Code	Modèle	Long. mm
4240031	G6774-45	45
4240060	G6774-50	50
4240099	G6774-56	56
4240125	G6774-62	62

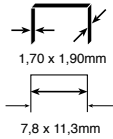

TAMAÑO REAL  
TAMANHO REAL  
ACTUAL SIZE  
TAILLE RÉELLE

SENCO Q  
PREBENA Q  
HAUBOLD HD7800  
BEA 180  
ATRO 18NC

**15**  
GAUGE

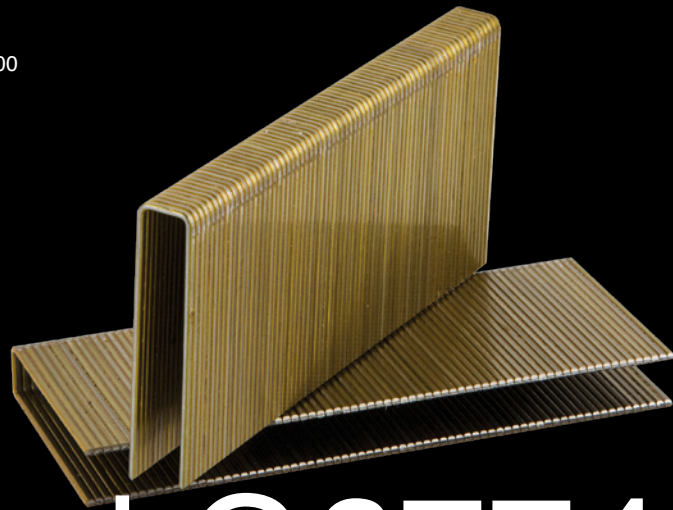

# mod G6774



CONSTRUCCIÓN  
CONSTRUÇÃO  
CONSTRUCTION  
CONSTRUCTION



EMBALAJE MADERA  
EMBALAGEM DE MADEIRA  
CRATES  
EMBALLAGE EN BOIS



CARPINTERÍA  
CARPINTARIA  
CARPENTRY  
MENUISERIE



EBANISTERIA Y MUEBLES  
MARCENARIA E MÓVEIS  
JOINERY AND FURNITURE  
MENUISERIE ET MEUBLES



PALETS  
PALETTES  
PALETTES  
PALETTES

- E** Recubrimiento del alambre: galvanizado.
- P** Revestimento de fio: galvanizado.
- UK** Wire coating: galvanized.
- F** Revêtement de fil: galvanisé.

## simG6774

1205174

TIPO / TIPO / TYPE / TYPE

Neumática / Pneumática / Pneumatic / Pneumatique

GRAPA / AGRAFO / STAPLE / AGRAFE

G6774. 32-64 mm

PRESIÓN / PRESSÃO / PRESSURE / PRESSION

5 - 8 atm

PESO / PESO / WEIGHT / POIDS

2,6 Kg

CAPACIDAD / CAPACIDADE / CAPACITY / CAPACITÉ

130 grapas / agrafos / staples / agrafes



AMAESTRI  
BEA  
CORGRAP  
DUOFAST  
BOSTITCH



13  
GAUGE

GRAPAS  
AGRAFOS  
STAPLES  
AGRAFES

1

Código	Modelo	Long. mm
Código	Modelo	Comp. mm
Code	Model	Length mm
Code	Modèle	Long. mm
4340054	35 - 15	15
4340083	35 - 18	18
4340085	35 - 22	22

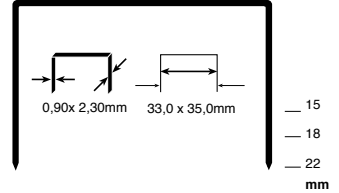

4340106	33 - 15	15
4340122	33 - 18	18
4308315	32 - 15	15
4340202	32 - 18	18

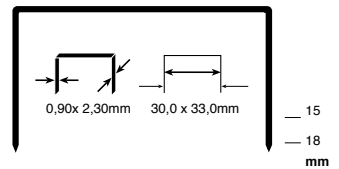

TAMAÑO REAL  
TAMANHO REAL  
ACTUAL SIZE  
TAILLE RÉELLE

# mod RM (35)

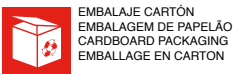

- E** Recubrimiento del alambre: cobreado.
- P** Revestimento de fio: chapeamento de cobre.
- UK** Wire coating: copper plated.
- F** Revêtement de fil: cuivré.

## Simes Neumática 35-22

3951940

TIPO / TIPO / TYPE / TYPE  
Neumática / Pneumática  
Pneumatic / Pneumatique  
GRAPA / AGRAFO / STAPLE / AGRAFE  
RM (35). 15-22 mm  
PRESIÓN / PRESSÃO  
PRESSURE / PRESSION  
4 - 7 atm

PESO / PESO / WEIGHT / POIDS  
2,65 Kg  
CAPACIDAD  
CAPACIDADE  
CAPACITY  
CAPACITÉ  
100 grapas / agrafos  
staples / agrafes



## Simes Neumática 35-18

3951935

TIPO / TIPO / TYPE / TYPE  
Neumática / Pneumática  
Pneumatic / Pneumatique  
GRAPA / AGRAFO / STAPLE / AGRAFE  
RM (35). 15-18 mm  
PRESIÓN / PRESSÃO  
PRESSURE / PRESSION  
4 - 7 atm

PESO / PESO / WEIGHT / POIDS  
2,65 Kg  
CAPACIDAD  
CAPACIDADE  
CAPACITY  
CAPACITÉ  
100 grapas / agrafos  
staples / agrafes



## Maestri Elpa BA 35

3100761

TIPO / TIPO / TYPE / TYPE  
Neumática / Pneumática  
Pneumatic / Pneumatique  
GRAPA / AGRAFO / STAPLE / AGRAFE  
RM (35). 15-18 mm  
PRESIÓN / PRESSÃO  
PRESSURE / PRESSION  
4 - 7 atm

PESO / PESO / WEIGHT / POIDS  
1,3 Kg  
CAPACIDAD  
CAPACIDADE  
CAPACITY  
CAPACITÉ  
87 grapas / agrafos  
staples / agrafes



## Maestri Elpa BH 35

3100732

TIPO / TIPO / TYPE / TYPE  
Neumática / Pneumática  
Pneumatic / Pneumatique  
GRAPA / AGRAFO / STAPLE / AGRAFE  
RM (35). 15-18 mm  
PESO / PESO / WEIGHT / POIDS  
1,3 Kg  
CAPACIDAD / CAPACIDADE  
CAPACITY / CAPACITÉ  
87 grapas / agrafos / staples / agrafes



1

**GRAPAS  
AGRAFOS  
STAPLES  
AGRAFES**

Código	Modelo	Long. mm
Código	Modelo	Comp. mm
Code	Model	Length mm
Code	Modèle	Long. mm
4341150	TOP - 15	15
4341189	TOP - 18	18

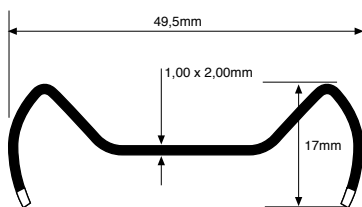

TAMAÑO REAL  
TAMANHO REAL  
ACTUAL SIZE  
TAILLE RÉELLE

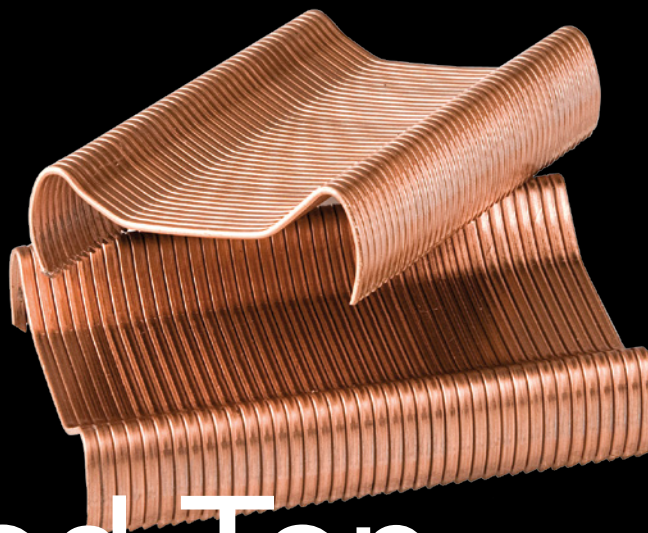
**13**  
GAUGE

# mod Top



EMBALAJE CARTÓN  
EMBALAGEM DE PAPELÃO  
CARDBOARD PACKAGING  
EMBALLAGE EN CARTON

- E** Recubrimiento del alambre: cobreado.
- P** Revestimento de fio: chapeamento de cobre.
- UK** Wire coating: copper plated.
- F** Revêtement de fil: cuivré.

**Mod 631**
**3100677**

TIPO / TIPO / TYPE / TYPE

Manual / Manual / Manual / Manuelle

GRAPA / AGRAFO / STAPLE / AGRAFE

Top 18

PESO / PESO / WEIGHT / POIDS

2,31Kg

CAPACIDAD / CAPACIDADE / CAPACITY / CAPACITÉ

120 grapas / agrafos staples / agrafes

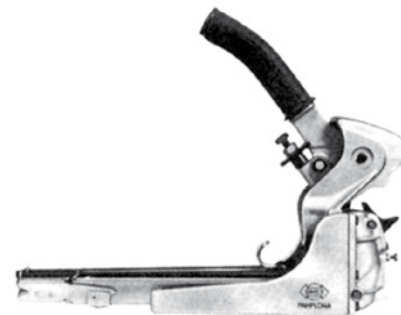
**Mod 632**
**3100703**

TIPO / TIPO / TYPE / TYPE

Neumática / Pneumática / Pneumatic / Pneumatique

GRAPA / AGRAFO / STAPLE / AGRAFE

Top 18

PRESIÓN / PRESSÃO / PRESSURE / PRESSION

4 - 6 atm

PESO / PESO / WEIGHT / POIDS

2,31Kg

CAPACIDAD / CAPACIDADE / CAPACITY / CAPACITÉ

120 grapas / agrafos staples / agrafes



18  
GAUGE

# mod Arrow T-50

GRAPAS  
AGRAFOS  
STAPLES  
AGRAFES

1

Código	Modelo	Long. mm
Código	Modelo	Comp. mm
Code	Model	Length mm
Code	Modèle	Long. mm
4415006	T 50 - 6	6
4415008	T 50 - 8	8
4415010	T 50 - 10	10
4415012	T 50 - 12	12
4415014	T 50 - 14	14

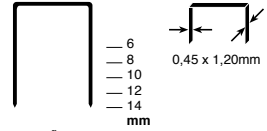

TAMAÑO REAL  
TAMANHO REAL  
ACTUAL SIZE  
TAILLE RÉELLE



- E** Recubrimiento del alambre: galvanizado.
- P** Revestimento de fio: galvanizado.
- UK** Wire coating: galvanized.
- F** Revêtement du fils: galvanisé.

## Arrow Mod T-50

3410050

TIPO / TIPO / TYPE / TYPE

Manual / Manual / Manual / Manuelle

GRAPA / AGRAFO / STAPLE / AGRAFE

T-50. 6-14 mm



1

**GRAPAS  
AGRAFOS  
STAPLES  
AGRAFES**

Código	Modelo	Long. mm
Código	Modelo	Comp. mm
Code	Model	Length mm
Code	Modèle	Long. mm
4306001	STCR 2115-1/4	6
4306014	STCR 2115-3/8	10

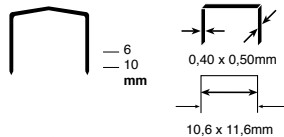

TAMAÑO REAL  
TAMANHO REAL  
ACTUAL SIZE  
TAILLE RÉELLE

**25**  
GAUGE

mod  
**STCR2115**



INDÚSTRIA GERAL  
INDÚSTRIA EM GERAL  
GENERAL INDUSTRY  
L'INDUSTRIE EN GÉNÉRAL

- E** Recubrimiento del alambre: galvanizado.
- P** Revestimento de fio: galvanizado.
- UK** Wire coating: galvanized.
- F** Revêtement de fil: galvanisé.

### Simes Mod. B8

3810118

TIPO / TIPO / TYPE / TYPE

Manual / Manual / Manual / Manuelle

GRAPA / AGRAFO / STAPLE / AGRAFE

STCR2115. 6-10 mm

PESO / PESO / WEIGHT / POIDS 0,40 Kg

CAPACIDAD / CAPACIDADE / CAPACITY / CAPACITÉ

210 grapas / agrafos staples / agrafes

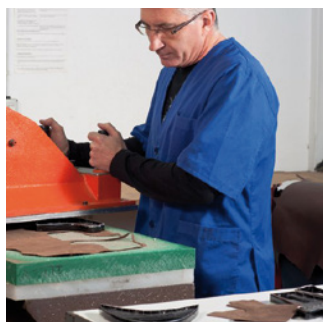

17  
GAUGE

# mod STCR5019



INDUSTRIA GENERAL  
INDUSTRIA EM GERAL  
GENERAL INDUSTRY  
L'INDUSTRIE EN GÉNÉRAL

- E** Recubrimiento del alambre: galvanizado.
- P** Revestimento de fio: galvanizado.
- UK** Wire coating: galvanized.
- F** Revêtement du fils: galvanisé.

## G5-OC 64227500

TIPO / TIPO / TYPE / TYPE  
Manual / Manual / Manual / Manuelle  
GRAPA / AGRAFO / STAPLE / AGRAFE  
STCR 5019  
PESO / PESO / WEIGHT / POIDS 0,9 Kg  
CAPACIDAD / CAPACIDADE / CAPACITY / CAPACITÉ  
84 grapas / agrafos staples / agrafes



DIVERGE LA GRAPA  
DIVERGE EL AGRAFO  
STAPLE DIVERGES  
DIVERGE L'AGRAFE



## G5-R 64227700

TIPO / TIPO / TYPE / TYPE  
Manual / Manual / Manual / Manuelle  
GRAPA / AGRAFO / STAPLE / AGRAFE  
STCR 5019  
PESO / PESO / WEIGHT / POIDS 0,91 Kg  
CAPACIDAD / CAPACIDADE / CAPACITY / CAPACITÉ  
84 grapas / agrafos staples / agrafes



GRAPA RECTA  
AGRAFO RETO  
STRAIGHT STAPLE  
AGRAFE DROIT



Código	Modelo	Long. mm
Código	Modelo	Comp. mm
Code	Model	Length mm
Code	Modèle	Long. mm
4306137	STCR 5019/6	6
4306140	STCR 5019/8	8
4306153	STCR 5019/10	10
4306166	STCR 5019/12	12
4306179	STCR 5019/14	14

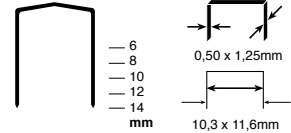

TAMAÑO REAL  
TAMANHO REAL  
ACTUAL SIZE  
TAILLE RÉELLE

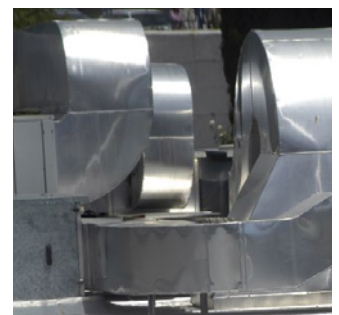

1

**GRAPAS  
AGRAFOS  
STAPLES  
AGRAFES**

Código	Modelo	Long. mm
Código	Modelo	Comp. mm
Code	Model	Length mm
Code	Modèle	Long. mm
4756009	W-9	9
4756012	W-12	12
4756015	W-15	15
4756109	WM-9	9
4756112	WM-12	12

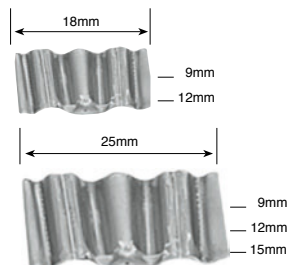

TAMAÑO REAL  
TAMANHO REAL  
ACTUAL SIZE  
TAILLE RÉELLE

SESCO P  
PREBENA WS  
KIHLBERG 784  
DUOFAS 17  
OMER WP

# Chapa Corrugada

CHAPA W CORRUGADA  
CORRUGATED W PLATE  
PLAQUE W ONDULÉE



INDUSTRIA GENERAL  
INDÚSTRIA EM GERAL  
GENERAL INDUSTRY  
L'INDUSTRIE EN GÉNÉRAL

- E** Recubrimiento del alambre: básico.
- P** Revestimento de fio: básico.
- UK** Wire coating: basic.
- F** Revêtement de fil: basique.

## simW25

1205625

TIPO / TIPO / TYPE / TYPE

Neumática / Pneumática / Pneumatic / Pneumatique

GRAPA / AGRAFO / STAPLE / AGRAFE

Chapa Corrugada W9. 12-15 mm

PRESIÓN / PRESSÃO / PRESSURE / PRESSION 5 - 8 atm

PESO / PESO / WEIGHT / POIDS 2,30 Kg

CAPACIDAD / CAPACIDADE / CAPACITY / CAPACITÉ

46 grapas / agrafos staples / agrafes







# Semclamp

Código Código Code Code	Modelo Modelo Model Modèle	Long. mm Comp. mm Length mm Long. mm
4754051	CLAMP - 8	8
4754080	CLAMP - 11	11
4754116	CLAMP - 14	14

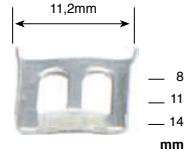

TAMAÑO REAL  
TAMANHO REAL  
ACTUAL SIZE  
TAILLE RÉELLE



- E** Recubrimiento del alambre: galvanizado.
- P** Revestimento de fio: galvanizado.
- UK** Wire coating: galvanized.
- F** Revêtement du fils: galvanisé.

## Senco SC1

1200225

TIPO / TIPO / TYPE / TYPE  
Neumática / Pneumática / Pneumatic / Pneumatique  
GRAPA / AGRAFO / STAPLE / AGRAFE  
Semclamp. 8-14 mm

PRESIÓN / PRESSÃO / PRESSURE / PRESSION  
5 - 8 atm

PESO / PESO / WEIGHT / POIDS  
2,80 Kg

CAPACIDAD / CAPACIDADE / CAPACITY / CAPACITÉ  
120 grapas / agrafos staples / agrafes



Código	Modelo	Long. mm
Código	Modelo	Comp. mm
Code	Model	Length mm
Code	Modèle	Long. mm

**B-10**

4766052	latón lisa latão lisa smooth brass laiton lisse	10
---------	--	----

4766104	bronce lisa bronzes lisa smooth bronze bronzes lisse	10
---------	---	----

4766159	oro viejo lisa ouro velho lisa smooth old gold or vieil lisse	10
---------	--	----

**B-6**

4786014	anillada bronce anelado bronce bronzes ringed annelé bronzes	6
---------	---	---

4786008	anillada níquel anelado níquel nickel ringed annelé nickel	6
---------	---	---

4786006	lisa níquel níquel lisa smooth nickel nickel lisse	6
---------	---	---

**B-10 PLÁSTICO / PLASTIC / PLASTIQUE**

4756135	blanco branco white blanc	10
---------	------------------------------------	----

4756136	beige bege beige beige	10
---------	---------------------------------	----

4756139	marrón oscuro marrom escuro dark brown brun foncé	10
---------	--	----

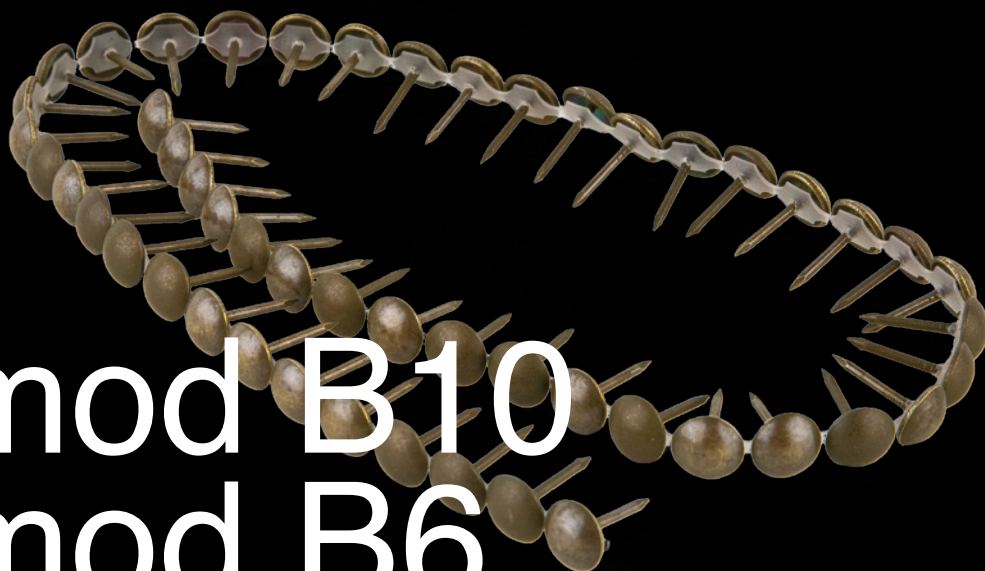
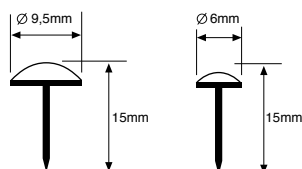

# mod B10

# mod B6



TAPICERÍA  
ESTOFAMENTO  
UPHOLSTERY  
TAPISSERIE



CALZADO  
CALÇADOS  
FOOTWEAR  
CHAUSSURES

- E** Recubrimiento del alambre: galvanizado.
- P** Revestimento de fio: galvanizado.
- UK** Wire coating: galvanized.
- F** Revêtement du fils: galvanisé.

## Chinchetadora / Agrafadora

### Tacker / Agrafeuse B10

3409985

TIPO / TIPO / TYPE / TYPE

Neumática / Pneumática / Pneumatic / Pneumatique

CHINCHETAS / AGRAFO / TACKS / AGRAFE B10

PRESIÓN / PRESSÃO / PRESSURE / PRESSION 5 - 6 atm

PESO / PESO / WEIGHT / POIDS 1,0 Kg

CAPACIDAD / CAPACIDADE / CAPACITY / CAPACITÉ

50 chinchetas / agrafos / tacks / agrafes



## Chinchetadora / Agrafadora

### Tacker / Agrafeuse B6

3409980

TIPO / TIPO / TYPE / TYPE

Neumática / Pneumática / Pneumatic / Pneumatique

CHINCHETAS / AGRAFO / TACKS / AGRAFE B6

PRESIÓN / PRESSÃO / PRESSURE / PRESSION 5 - 6 atm

PESO / PESO / WEIGHT / POIDS 1,0 Kg

CAPACIDAD / CAPACIDADE / CAPACITY / CAPACITÉ

75 chinchetas / agrafos / tacks / agrafes



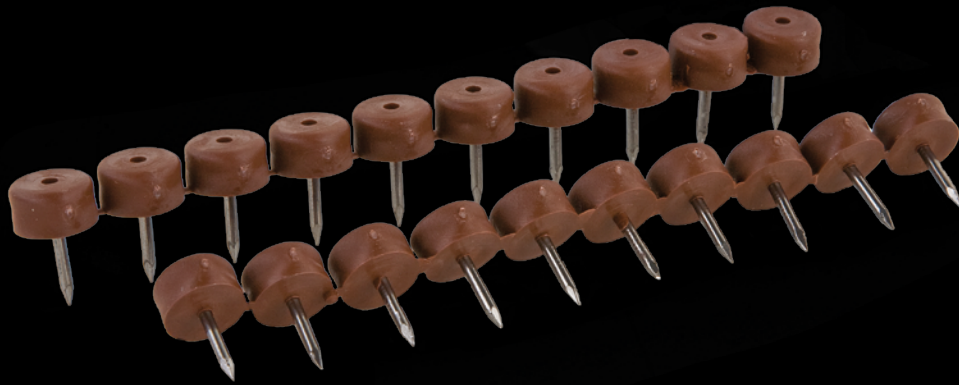

# Tacos 13

TACHA 13  
TACK 13  
CLOU 13

Código  
Código  
Code  
Code

4756130

Modelo  
Modelo  
Model  
Modèle

Taco



TAMAÑO REAL  
TAMANHO REAL  
ACTUAL SIZE  
TAILLE RÉELLE



PUERTAS  
PORTAS  
DOORS  
PORTES

- E** Plástico marrón.
- P** Plástico marrom.
- UK** Brown plastic.
- F** Plastique brune.

## Clavadora / Agrafadora Tacker / Agrafeuse Ø13

64227401

TIPO / TIPO / TYPE / TYPE

Neumática / Pneumática / Pneumatic / Pneumatique

GRAPA / AGRAFO / STAPLE / AGRAFE

Taco / Tacha / Tack / Clou Ø13 mm

PRESIÓN / PRESSÃO / PRESSURE / PRESSION

5 - 7 atm



1

**GRAPAS  
AGRAFOS  
STAPLES  
AGRAFES**

Código	Modelo	Long. mm
Código	Modelo	Comp. mm
Code	Model	Length mm
Code	Modèle	Long. mm
4481159	Roc77	9,5

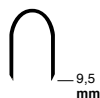

TAMAÑO REAL  
TAMANHO REAL  
ACTUAL SIZE  
TAILLE RÉELLE

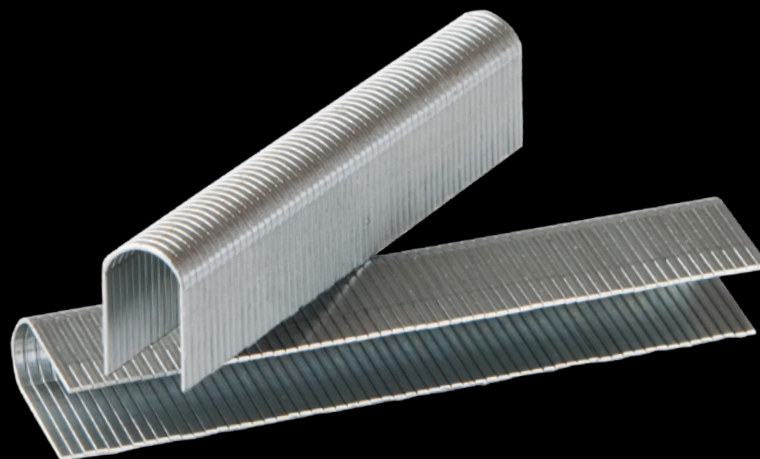

# mod Roc77



HILO TELEFÓNICO  
FIO DE TELEFONE  
TELEPHONE LINE  
FIL DE TÉLÉPHONE

- E** Recubrimiento del alambre: galvanizado.
- P** Revestimento de fio: galvanizado.
- UK** Wire coating: galvanized.
- F** Revêtement du fils: galvanisé.

## Simes mod 100

3409035

TIPO / TIPO / TYPE / TYPE

Manual / Manual / Manual / Manuelle

GRAPA / AGRAFO / STAPLE / AGRAFE

Roc77

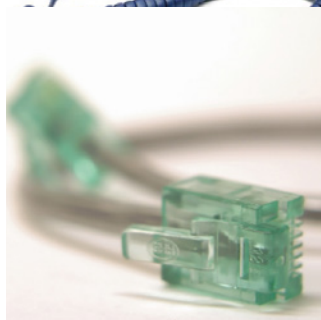
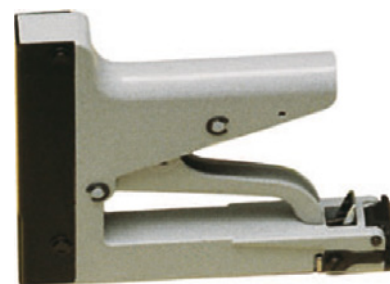

SENCO AT  
PREBENA A  
KIHLBERG 680  
HAUBOLD 800  
DUOFAST 80  
BOSTITCH 86/AZ33  
BEA 80/380-ATRO 8 (80)  
OMER 80

15  
GAUGE

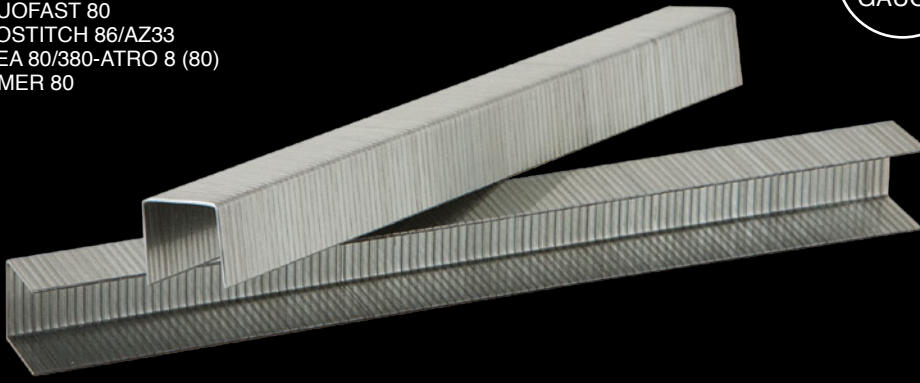

mod 110

GRAPAS  
AGRAFOS  
STAPLES  
AGRAFES

1

Código	Modelo	Long. mm
Código	Modelo	Comp. mm
Code	Model	Length mm
Code	Modèle	Long. mm
4490700	110-16	16
4490710	110-18	18
4490711	110-20	20

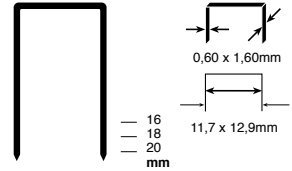

TAMAÑO REAL  
TAMANHO REAL  
ACTUAL SIZE  
TAILLE RÉELLE

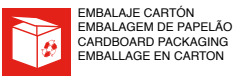

- E** Recubrimiento del alambre: galvanizado.
- P** Revestimento de fio: galvanizado.
- UK** Wire coating: galvanized.
- F** Revêtement du fils: galvanisé.

Código	Modelo	Long. mm
Código	Modelo	Comp. mm
Code	Model	Length mm
Code	Modèle	Long. mm
4490916	9-16	16
4490918	9-18	18
4490920	9-20	20
4490922	9-22	22
4490924	9-24	24

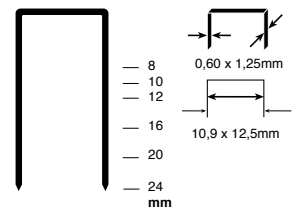

TAMAÑO REAL  
TAMANHO REAL  
ACTUAL SIZE  
TAILLE RÉELLE

SENCO AT  
PREBENA A  
KIHLBERG 680  
HAUBOLD 800  
DUOFAST 80  
BOSTITCH 86/AZ33  
BEA 80/380-ATRO 8 (80)  
OMER 80

17  
GAUGE



mod 9

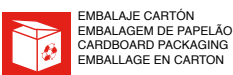

- E** Recubrimiento del alambre: galvanizado.
- P** Revestimento de fio: galvanizado.
- UK** Wire coating: galvanized.
- F** Revêtement du fils: galvanisé.



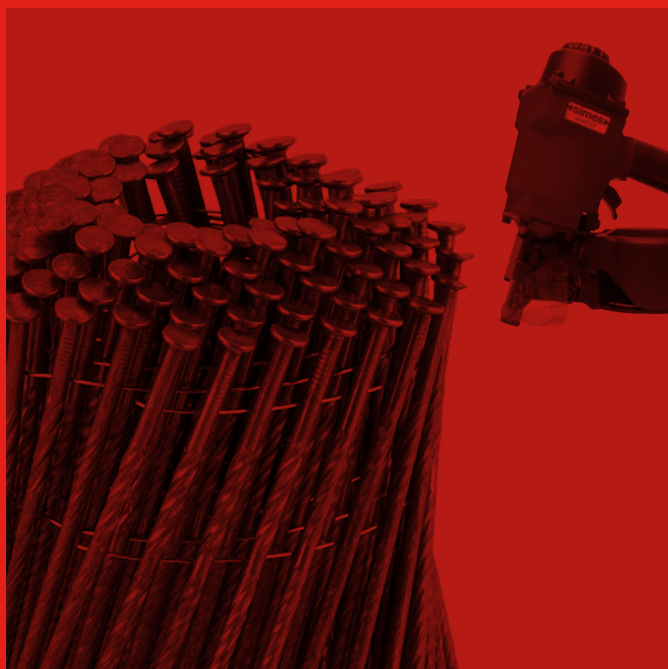

# 2

**CLAVOS**  
**PREGOS**  
**NAILS**  
**CLOUS**

Pin 0,6 JSI	32
Microbrad 0,6	33
Pin 0,8	34
Minibrad 0,8	35
Pin LSI / Brad LSII	36
Brad AX 1,2	37
Brad 1,53	38
Brad 1,83	39
T 2,2	40
DA	41
EC-GC-HF	42
Holz-Her	43
Coil 1,6	44
Coil 2,0 - 2,1	45
Coil 2,2 - 2,3	46
Coil 2,5	47
Coil 2,9	48
Coil 3,1	49
Coil 3,8	50
Hojas de sierras	50
Coil roofing	51

2

**CLAVOS  
PREGOS  
NAILS  
CLOUS**

Código	Modelo	Long. mm
Código	Modelo	Comp. mm
Code	Model	Length mm
Code	Modèle	Long. mm
4730087	JSI-12	12
4730089	JSI-15	15
4730090	JSI-18	18
4730098	JSI-25	25
4730103	JSI-30	30
4730135	JSI-35	35
4730140	JSI-40	40
4730145	JSI-45	45
4730150	JSI-50	50

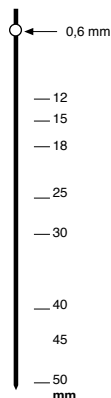

TAMAÑO REAL  
TAMANHO REAL  
ACTUAL SIZE  
TAILLE RÉELLE

SENCO CZ  
PREBENA AL  
KILHLBERG 506  
HAUBOLD ST06  
BEA S700  
ATRO MINI  
OMER PINS 0,6

23  
GAUGE

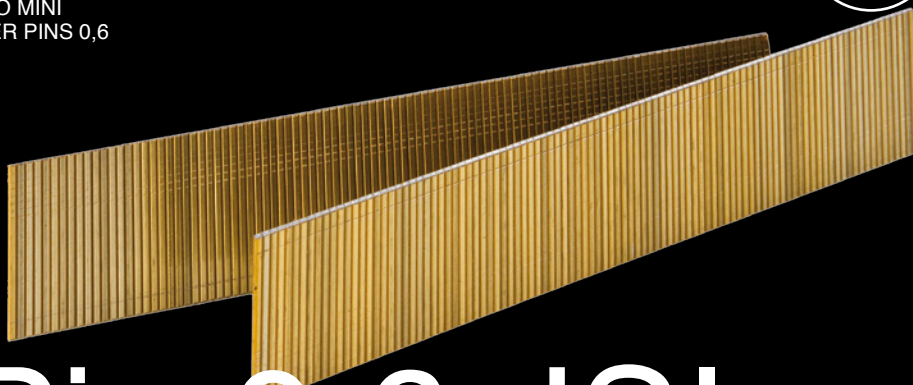

# Pin 0,6 JSI



CARPINTERÍA  
CARPINTARIA  
CARPENTRY  
MENUISERIE



EBANISTERÍA Y MUEBLES  
MARCENARIA E MÓVEIS  
JOINERY AND FURNITURE  
MENUISERIE ET MEUBLES



CONSTRUCCIÓN  
CONSTRUÇÃO  
CONSTRUCTION  
CONSTRUCTION

- E** Recubrimiento del alambre: galvanizado color oro.
- P** Revestimento de fio: ouro galvanizado.
- UK** Wire coating: galvanized gold.
- F** Revêtement du fils: galvanisé doré.

## simPB0635

1205635

TIPO / TIPO / TYPE / TYPE  
Neumática / Pneumática / Pneumatic / Pneumatic  
CLAVO / PREGO / NAIL / CLOU  
Pin 0,6. 12-35 mm

PRESIÓN / PRESSÃO / PRESSURE / PRESSION  
4 - 7 atm

PESO / PESO / WEIGHT / POIDS  
0,9 Kg

CAPACIDAD / CAPACIDADE / CAPACITY / CAPACITÉ  
100 pins



## simPB0645

1205645

TIPO / TIPO / TYPE / TYPE  
Neumática / Pneumática / Pneumatic / Pneumatic  
CLAVO / PREGO / NAIL / CLOU  
Pin 0,6. 12-45 mm

PRESIÓN / PRESSÃO / PRESSURE / PRESSION  
4 - 7 atm

PESO / PESO / WEIGHT / POIDS  
1,0 Kg

CAPACIDAD / CAPACIDADE / CAPACITY / CAPACITÉ  
108 pins





23  
GAUGE

CLAVOS  
PREGOS  
NAILS  
CLOUS

2



# Microbrad 0,6

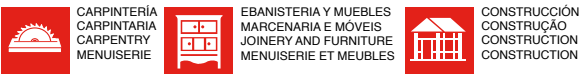

- E** Recubrimiento del alambre: galvanizado.
- P** Revestimento de fio: galvanizado.
- UK** Wire coating: galvanized.
- F** Revêtement du fils: galvanisé.

## simPB0635

1205635

TIPO / TIPO / TYPE / TYPE  
Neumática / Pneumática / Pneumatic / Pneumatique

CLAVO / PREGO / NAIL / CLOU  
Microbrad 0,6. 12-35 mm

PRESIÓN / PRESSÃO / PRESSURE / PRESSION  
4 - 7 atm

PESO / PESO / WEIGHT / POIDS  
0,9 Kg

CAPACIDAD / CAPACIDADE / CAPACITY / CAPACITÉ  
100 microbrads



## simPB0645

1205645

TIPO / TIPO / TYPE / TYPE  
Neumática / Pneumática / Pneumatic / Pneumatique

CLAVO / PREGO / NAIL / CLOU  
Microbrad 0,6. 12-45 mm

PRESIÓN / PRESSÃO / PRESSURE / PRESSION  
4 - 7 atm

PESO / PESO / WEIGHT / POIDS  
0,9 Kg

CAPACIDAD / CAPACIDADE / CAPACITY / CAPACITÉ  
108 microbrads



Código Código Code Code	Modelo Modelo Model Modèle	Long. mm Comp. mm Length mm Long. mm
4730220	0,6 x 20	20
4730225	0,6 x 25	25
4730230	0,6 x 30	30
4730235	0,6 x 35	35
4730240	0,6 x 40	40
4730245	0,6 x 45	45
4730250	0,6 x 50	50

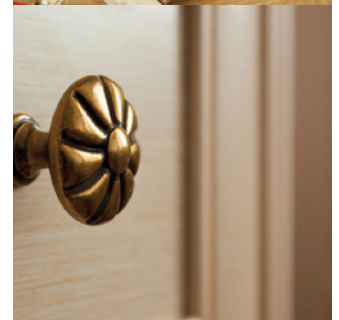
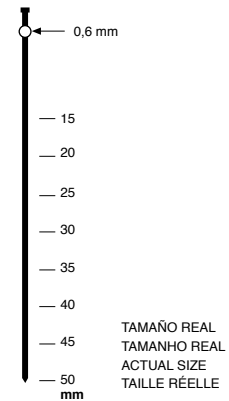

Código	Modelo	Long. mm
Código	Modelo	Comp. mm
Code	Model	Length mm
Code	Modèle	Long. mm
4730115	Pin 0,8 - 15	15
4730118	Pin 0,8 - 18	18
4730120	Pin 0,8 - 20	20
4730125	Pin 0,8 - 25	25
4730130	Pin 0,8 - 30	30
4731035	Pin 0,8 - 35	35
4731040	Pin 0,8 - 40	40

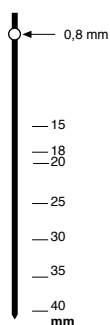

TAMAÑO REAL  
TAMANHO REAL  
ACTUAL SIZE  
TAILLE RÉELLE

PREBENA BE  
BOSTITCH MINIPIN 18  
HAUBOLD ST86  
DUOFAST MP  
ATRO MINI

21  
GAUGE

# pin 0,8



CARPINTERÍA  
CARPINTARIA  
CARPENTRY  
MENUISERIE



EBANISTERIA Y MUEBLES  
MARCENARIA E MÓVEIS  
JOINERY AND FURNITURE  
MENUISERIE ET MEUBLES



CONSTRUCCIÓN  
CONSTRUÇÃO  
CONSTRUCTION  
CONSTRUCTION

- E** Recubrimiento del alambre: galvanizado color oro.
- P** Revestimento de fio: ouro galvanizado.
- UK** Wire coating: galvanized gold
- F** Revêtement du fils: or galvanisé.

## simPB08

1205084

TIPO / TIPO / TYPE / TYPE

Neumática / Pneumática / Pneumatic / Pneumatique

CLAVO / PREGO / NAIL / CLOU

Pin 0,8. 15-45 mm

PRESIÓN / PRESSÃO / PRESSURE / PRESSION

4 - 7 atm

PESO / PESO / WEIGHT / POIDS

1,1 Kg

CAPACIDAD / CAPACIDADE / CAPACITY / CAPACITÉ

150 pins



PREBENA JA  
DUO FAST MB  
BEA SK200  
ATRO MINI TIP  
OMER BRADS M

21  
GAUGE

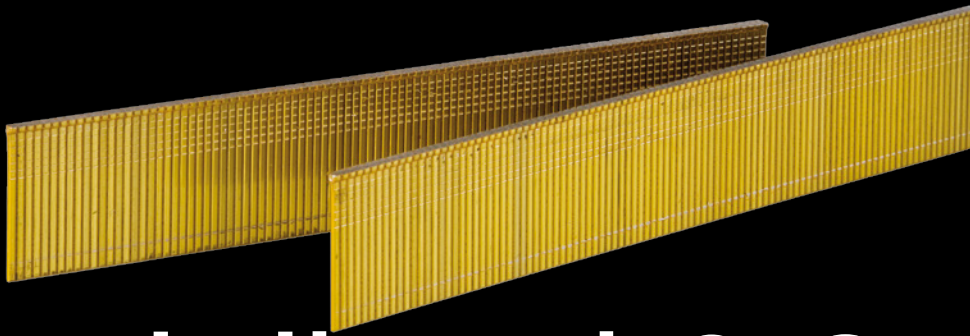

# minibrad 0,8



CARPINTERÍA  
CARPINTARIA  
CARPENTRY  
MENUISERIE



EBANISTERIA Y MUEBLES  
MARCNARIA E MÓVEIS  
JOINERY AND FURNITURE  
MENUISERIE ET MEUBLES



CONSTRUCCIÓN  
CONSTRUÇÃO  
CONSTRUCTION  
CONSTRUCTION

- E** Recubrimiento del alambre: galvanizado color oro.
- P** Revestimento de fio: ouro galvanizado
- UK** Wire coating: galvanized gold.
- F** Revêtement du fils: galvanisé doré.

## simPB08

1205084

TIPO / TIPO / TYPE / TYPE

Neumática / Pneumática / Pneumatic / Pneumatique

CLAVO / PREGO / NAIL / CLOU

Minibrad 0,8. 15-45 mm

PRESIÓN / PRESSÃO / PRESSURE / PRESSION

4 - 7 atm

PESO / PESO / WEIGHT / POIDS

1,1 Kg

CAPACIDAD / CAPACIDADE / CAPACITY / CAPACITÉ

150 minbrads



## Maestri ME-0,8/30

3810225

TIPO / TIPO / TYPE / TYPE

Eléctrica / Elétrica / Electric / Électrique

CLAVO / PREGO / NAIL / CLOU

Minibrad 0,8. 15-30 mm

TENSIÓN / TENSÃO / VOLTAGE / TENSION

220 V.

PESO / PESO / WEIGHT / POIDS

1,40 Kg

CAPACIDAD / CAPACIDADE / CAPACITY / CAPACITÉ

135 minbrads



CLAVOS  
PREGOS  
NAILS  
CLOUS

2

Código Código Code Code	Modelo Modelo Model Modèle	Long. mm Comp. mm Length mm Long. mm
4741015	15	15
4741020	20	20
4741025	25	25
4741030	30	30
4741035	35	35
4741040	40	40

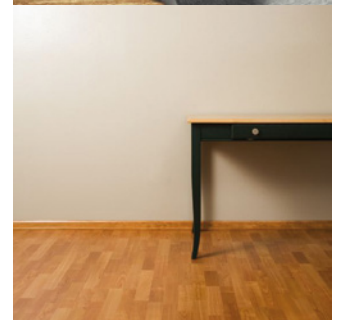
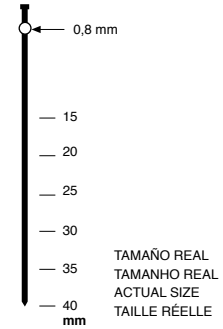

Código	Modelo	Long. mm
Código	Modelo	Comp. mm
Code	Model	Length mm
Code	Modèle	Long. mm

## PIN LSI

4731032	LSI - 15	15
4731061	LSI - 20	20
4731090	LSI - 25	25
4731113	LSI - 30	30

## BRAD LSII

4742013	LS II -13	13
4742050	LS II -15	15
4742306	LS II -18	18
4742089	LS II -20	20
4742115	LS II - 25	25
4742144	LS II - 30	30
4742145	LS II - 32	32
4742147	LS II - 35	35
4742148	LS II - 38	38
4742150	LS II - 40	40
4742151	LS II - 42	42

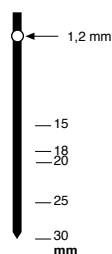

TAMAÑO REAL  
TAMANHO REAL  
ACTUAL SIZE  
TAILLE RÉELLE

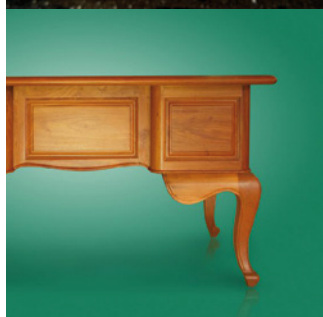

SENCO AZ  
PREBENA GA-PINS  
DUOFAST 1  
BOSTITCH AZ5550  
BEA 80/38  
ATRO 1

18  
GAUGE

# pin LSI brad LSII



CARPINTERÍA  
CARPINTARIA  
CARPENTRY  
MENUISERIE



EBANISTERIA Y MUEBLES  
MARCENARIA E MÓVEIS  
JOINERY AND FURNITURE  
MENUISERIE ET MEUBLES



CONSTRUÇÃO  
CONSTRUCÇÃO  
CONSTRUCTION  
CONSTRUCTION

- E** Recubrimiento del alambre: galvanizado color oro, aluminio.
- P** Revestimento de fio: ouro galvanizado, alumínio.
- UK** Wire coating: galvanized gold, aluminium.
- F** Revêtement du fils: galvanisé doré, aluminium.

## simB12

1205125

TIPO / TIPO / TYPE / TYPE

Neumática / Pneumática / Pneumatic / Pneumatique

PIN LSI

BRAD LSII. 15-50 mm

PRESIÓN / PRESSÃO / PRESSURE / PRESSION

5 - 7 atm

PESO / PESO / WEIGHT / POIDS

1,4 Kg

CAPACIDAD / CAPACIDADE / CAPACITY / CAPACITÉ

100 pins / brads



SECO AX  
 PREBENA JM  
 BOSTQITCH BT1300  
 KIHLBERG 512  
 HAUBOLD SKN12  
 DUOFAST B44  
 ATRO TIPIN  
 OMER BRADS 12  
 PASSLODE F18

18  
 GAUGE

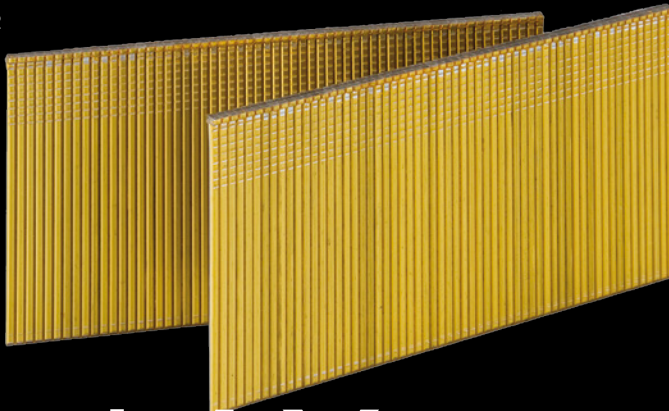

# brad AX 1,2



CARPINTERÍA  
 CARPINTARIA  
 CARPENTRY  
 MENUISERIE



EBANISTERÍA Y MUEBLES  
 MARCENARIA E MÓVEIS  
 JOINERY AND FURNITURE  
 MENUISERIE ET MEUBLES



CONSTRUCCIÓN  
 CONSTRUÇÃO  
 CONSTRUCTION  
 CONSTRUCTION

- E** Recubrimiento del alambre: galvanizado color oro, acero.
- P** Revestimento de fio: ouro galvanizado, aço.
- UK** Wire coating: galvanized gold, steel.
- F** Revêtement du fils: galvanisé doré, acier.

## simB12

1205125

TIPO / TIPO / TYPE / TYPE  
 Neumática / Pneumática / Pneumatic / Pneumatique

BRAD

AX 1,2. 15-50 mm

PRESIÓN / PRESSÃO / PRESSURE / PRESSION  
 5 - 7 atm

PESO / PESO / WEIGHT / POIDS  
 1,4 Kg

CAPACIDAD / CAPACIDADE / CAPACITY / CAPACITÉ  
 100 brads



## simB12 Acero / Aço / Steel / Acier

1205126

TIPO / TIPO / TYPE / TYPE  
 Neumática / Pneumática / Pneumatic / Pneumatique

BRAD

AX 1,2. 15-50 mm / AX1,2. 12-40mm acero / aço / steel / acier

PRESIÓN / PRESSÃO / PRESSURE / PRESSION  
 5 - 7 atm

PESO / PESO / WEIGHT / POIDS  
 1,45 Kg

CAPACIDAD / CAPACIDADE / CAPACITY / CAPACITÉ  
 100 brads



## Maestri ME-30

3810230

TIPO / TIPO / TYPE / TYPE  
 Eléctrica / Elétrica / Electric / Électrique

BRAD

AX 1,2. 15-30 mm

PRESIÓN / PRESSÃO / PRESSURE / PRESSION  
 5 - 8 atm

PESO / PESO / WEIGHT / POIDS  
 1,4 Kg

CAPACIDAD / CAPACIDADE / CAPACITY / CAPACITÉ  
 100 brads



CLAVOS  
 PREGOS  
 NAILS  
 CLOUS **2**

Código Código Code Code	Modelo Modelo Model Modèle	Long. mm Comp. mm Length mm Long. mm
4742312	AX - 13	12
4742315	AX - 15	15
4742320	AX - 20	20
4742325	AX - 25	25
4742330	AX - 30	30
4742332	AX - 32	32
4742335	AX - 35	35
4742338	AX - 38	38
4742340	AX - 40	40
4742345	AX - 45	45
4742350	AX - 50	50

ACERO / AÇO / STEEL / ACIER	
4743220 Brad Acero - 20	20
4743225 Brad Acero - 25	25
4743230 Brad Acero - 30	30
4743235 Brad Acero - 35	35
4743240 Brad Acero - 40	40

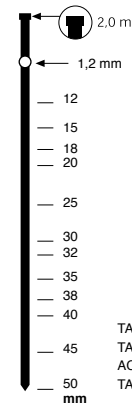

TAMAÑO REAL  
 TAMANHO REAL  
 ACTUAL SIZE  
 TAILLE RÉELLE

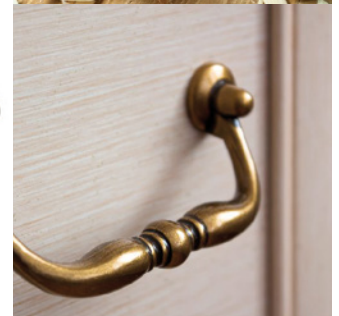

Código	Modelo	Long. mm
Código	Modelo	Comp. mm
Code	Model	Length mm
Code	Modèle	Long. mm
4742420	Brad 1,53 - 20	20
4742425	Brad 1,53 - 25	25
4742430	Brad 1,53 - 30	30
4742435	Brad 1,53 - 35	35
4742438	Brad 1,53 - 38	38
4742440	Brad 1,53 - 40	40
4742445	Brad 1,53 - 45	45
4742450	Brad 1,53 - 50	50
4742455	Brad 1,53 - 55	55
4742460	Brad 1,53 - 60	60
4742462	Brad 1,53 - 62	62

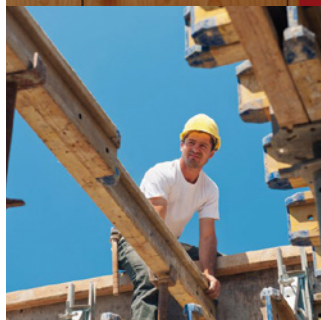
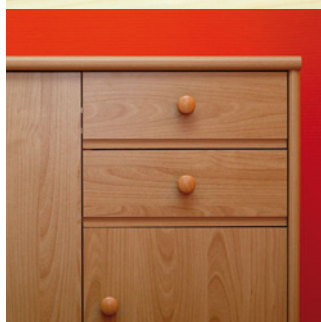
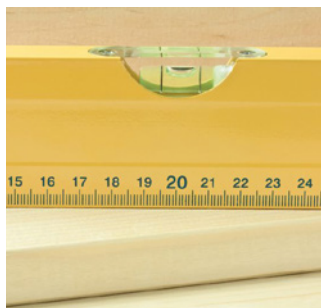
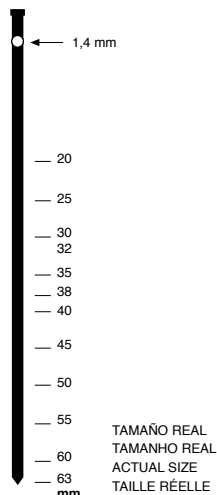

PREBENA N  
KILHLBERG 516  
HAUBOLD SKN16  
DUO FAST HB60  
BOSTITCH BTT200  
BEA SK400  
ATRO TIP  
OMER BRAD 14  
PASSLODE F16

16  
GAUGE

brad 1,53



CARPINTERÍA  
CARPINTARIA  
CARPENTRY  
MENUISERIE



EBANISTERIA Y MUEBLES  
MARCENARIA E MÓVEIS  
JOINERY AND FURNITURE  
MENUISERIE ET MEUBLES



CONSTRUCCIÓN  
CONSTRUÇÃO  
CONSTRUCTION  
CONSTRUCTION

- E** Recubrimiento del alambre: galvanizado.
- P** Revestimento de fio: galvanizado.
- UK** Wire coating: galvanized.
- F** Revêtement du fils: galvanisé.

### simB153

1205156

TIPO / TIPO / TYPE / TYPE

Neumática / Pneumática / Pneumatic / Pneumatique

BRAD

1,53. 32-64 mm

PRESIÓN / PRESSÃO / PRESSURE / PRESSION

5 - 8 atm

PESO / PESO / WEIGHT / POIDS

1,7 Kg

CAPACIDAD / CAPACIDADE / CAPACITY / CAPACITÉ

100 brads



15  
GAUGE

CLAVOS  
PREGOS  
NAILS  
CLOUS

2

# brad 1,83



- E** Recubrimiento del alambre: básico templado color negro, básico templado color oro.
- P** Revestimento de fio: preto básico temperado, ouro básica temperado.
- UK** Wire coating: basic tempered black, basic tempered gold.
- F** Revêtement du fils: basique trempé noire, basique trempé doré.

## simB183

1205185

TIPO / TIPO / TYPE / TYPE

Neumática / Pneumática / Pneumatic / Pneumatique

BRAD

1,83. 18-50 mm

PRESIÓN / PRESSÃO / PRESSURE / PRESSION

5 - 8 atm

PESO / PESO / WEIGHT / POIDS

1,9 Kg

CAPACIDAD / CAPACIDADE / CAPACITY / CAPACITÉ

98 brads

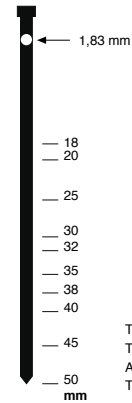

TAMAÑO REAL  
TAMANHO REAL  
ACTUAL SIZE  
TAILLE RÉELLE



Código	Modelo	Long. mm
Código	Modelo	Comp. mm
Code	Model	Length mm
Code	Modèle	Long. mm
4690925	T- Nail 25	25
4690932	T- Nail 32	30
4690938	T- Nail 38	38
4690945	T- Nail 45	45
4690950	T- Nail 50	50
4690955	T- Nail 55	54
4690960	T- Nail 60	60
4690964	T- Nail 64	64
4680518	T- 18 Templado	18
4680507	T- 25 Templado	25
4680549	T- 32 Templado	32
4680552	T- 38 Templado	38
4680557	T- 45 Templado	45
4680559	T- 50 Templado	50
4680563	T- 60 Templado	60
4680566	T- 64 Templado	64
4680569	T- 75 Templado	75

BEA  
FASCO13  
GAUGE

T 2,2

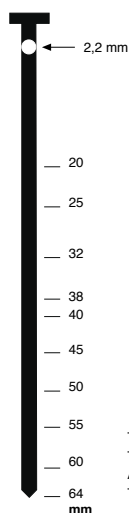
INDUSTRIA GENERAL  
INDÚSTRIA EM GERAL  
GENERAL INDUSTRY  
L'INDUSTRIE EN GÉNÉRALCOLCHONERÍA  
COLCHÕES  
MATTRESSES  
MATELASCONSTRUCCIÓN  
CONSTRUÇÃO  
CONSTRUCTION  
CONSTRUCTION

- E** Recubrimiento del alambre: básico, básico templado.
- P** Revestimento de fio: básico, temperado básico.
- UK** Wire coating: basic, basic black, basic tempered.
- F** Revêtement du fils: basique, basique trempé.

**simCT64**

1205226

TIPO / TIPO / TYPE / TYPE

Neumática / Pneumática / Pneumatic / Pneumatique

CLAVO / PREGO / NAIL / CLOU

T2,2. 18-64 mm

PRESIÓN / PRESSÃO / PRESSURE / PRESSION

5 - 8 atm

PESO / PESO / WEIGHT / POIDS

2,6 Kg

CAPACIDAD / CAPACIDADE / CAPACITY / CAPACITÉ

80 clavos / pregos / nails / clous





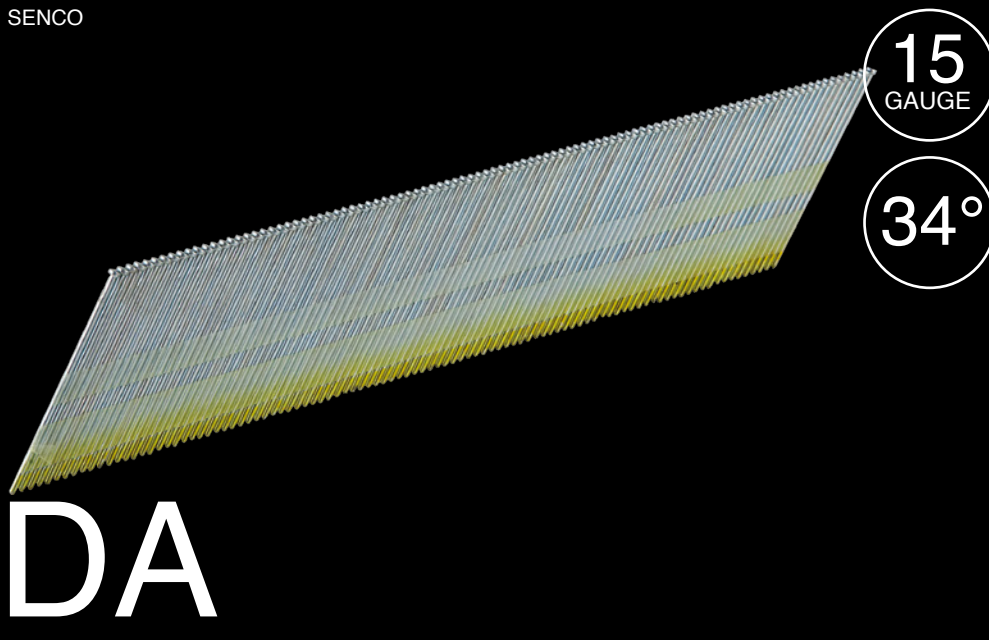

# DA

Código	Modelo	Long. mm
Código	Modelo	Comp. mm
Code	Model	Length mm
Code	Modèle	Long. mm

LISO / SUAVE / SMOOTH / LISSE		
4523011	DA 11 - 20	20
4711325	DA 13 - 25	25
4711532	DA 15 - 32	32
4711737	DA 17 - 37	37
4711945	DA 19 - 45	45
4712150	DA 21 - 50	50
4712357	DA 23 - 57	57
4712563	DA 25 - 62	62



-  EMBALAJE MADERA  
EMBALAGEM DE MADEIRA  
CRATES  
EMBALLAGE EN BOIS
-  CONSTRUCCIÓN  
CONSTRUÇÃO  
CONSTRUCTION  
CONSTRUCTION
-  CARPINTERÍA  
CARPINTARIA  
CARPENTRY  
MENUISERIE
-  EBANISTERIA Y MUEBLES  
MARCENARIA E MÓVEIS  
JOINERY AND FURNITURE  
MENUISERIE ET MEUBLES
-  COLCHONERÍA  
COLCHÕES  
MATTRESSES  
MATELAS

- E** Recubrimiento del alambre: básico.
- P** Revestimento de fio: básico.
- UK** Wire coating: basic.
- F** Revêtement du fils: basique.

## Senco SFN-30

**1200195**  
 TIPO / TIPO / TYPE / TYPE  
 Neumática / Pneumática / Pneumatic / Pneumatique  
 CLAVO / PREGO / NAIL / CLOU  
 DA. 20-50 mm  
 PRESIÓN / PRESSÃO / PRESSURE / PRESSION  
 5 - 8 atm  
 PESO / PESO / WEIGHT / POIDS  
 1,6 Kg  
 CAPACIDAD / CAPACIDADE / CAPACITY / CAPACITÉ  
 104 clavos / pregos / nails / clous



## Senco Finish Pro 35

**1200135**  
 TIPO / TIPO / TYPE / TYPE  
 Neumática / Pneumática / Pneumatic / Pneumatique  
 CLAVO / PREGO / NAIL / CLOU  
 DA. 32-63 mm  
 PRESIÓN / PRESSÃO / PRESSURE / PRESSION  
 5 - 8 atm  
 PESO / PESO / WEIGHT / POIDS  
 2,1 Kg  
 CAPACIDAD / CAPACIDADE / CAPACITY / CAPACITÉ  
 104 clavos / pregos / nails / clous



Código	Ømm	Modelo	Long. mm
Código	Ømm	Modelo	Comp. mm
Code	Ømm	Model	Length mm
Code	Ømm	Modèle	Long. mm

LISO / SMOOTH / LISSE

4560025	2,3	EC 47 - 40	40
4560041	2,3	EC 49 - 45	45
4705150	2,3	EC 51 - 50	50
4705255	2,3	EC 52 - 55	55
4705460	2,3	EC 54 - 60	60
4725565	2,87	GC 55 - 65	65
4725670	2,87	GC 56 - 70	70
4745775	3,1	HC 57 - 75	75
4745880	3,1	HC 58 - 80	80
4745990	3,1	HC 59 - 90	90

ROSCADO / SCREW / TORSADÉ

4765565	3,1	HF 55 - 65	65
4765670	3,1	HF 56 - 70	70
4765775	3,1	HF 57 - 75	75
4765880	3,1	HF 58 - 80	80
4765990	3,1	HF 59 - 90	90

SENCO

13 11  
10  
GAUGE

34°

EC-GC-HF

TAPICERÍA  
ESTOFAMENTO  
UPHOLSTERY  
TAPISSERIEPELETERÍA  
PELE  
FUR  
FOURRURECARPINTERÍA  
CARPINTARIA  
CARPENTRY  
MENUISERIEEBANISTERÍA Y MUEBLES  
MARCNARIA E MÓVEIS  
JOINERY AND FURNITURE  
MENUISERIE ET MEUBLESCOLCHONERÍA  
COLCHÕES  
MATTRESSES  
MATELAS

- E** Recubrimiento del alambre: básico.
- P** Revestimiento de fio: básico.
- UK** Wire coating: basic.
- F** Revêtement du fils: basique.

**FramePro 601**

1200156

TIPO / TIPO / TYPE / TYPE

Neumática / Pneumática / Pneumatic / Pneumatique

CLAVO / PREGO / NAIL / CLOU

EC-GC-HF. 50-90 mm

PRESIÓN / PRESSÃO / PRESSURE / PRESSION

5 - 8 atm

PESO / PESO / WEIGHT / POIDS

3,62 Kg

CAPACIDAD / CAPACIDADE / CAPACITY / CAPACITÉ

70 clavos / pregos / nails / clous

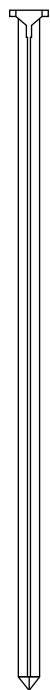
TAMAÑO REAL  
TAMANHO REAL  
ACTUAL SIZE  
TAILLE RÉELLE

11 10  
8 7  
GAUGE

22°

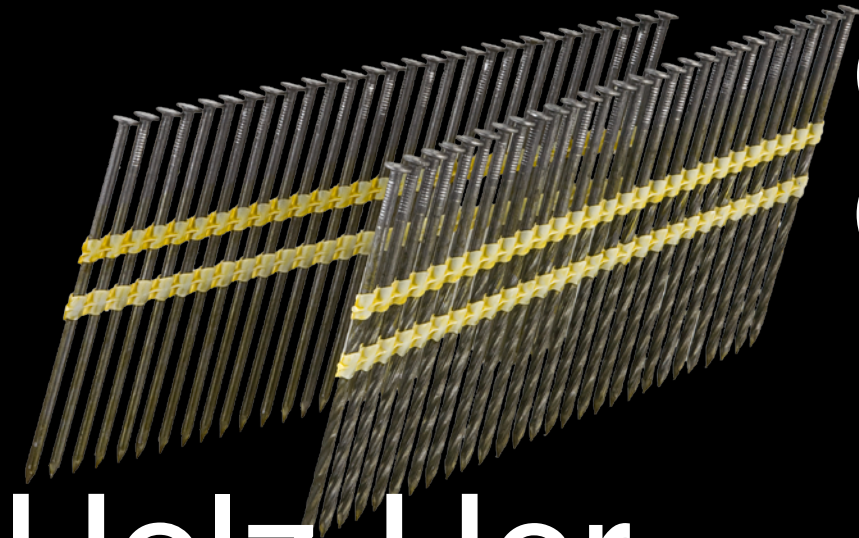

# Holz-Her



CONSTRUÇÃO  
CONSTRUCÃO  
CONSTRUCTION  
CONSTRUCTION



PALETS  
PALLETS  
PALETTES  
PALETTES



EMBALAJE MADERA  
EMBALAGEM DE MADEIRA  
CRATES  
EMBALLAGE EN BOIS

- E** Recubrimiento del alambre: básico.
- P** Revestimento de fio: básico.
- UK** Wire coating: basic.
- F** Revêtement du fils: basique.

## simCH130

1205130

TIPO / TIPO / TYPE / TYPE

Neumática / Pneumática / Pneumatic / Pneumatique

CLAVO / PREGO / NAIL / CLOU

Holz-Her. 80-130 mm

PRESIÓN / PRESSÃO / PRESSURE / PRESSION

5 - 8 atm

PESO / PESO / WEIGHT / POIDS

6,1 Kg

CAPACIDAD / CAPACIDADE / CAPACITY / CAPACITÉ

54 clavos / pregos / nails / clous



## simCH160

1205160

TIPO / TIPO / TYPE / TYPE

Neumática / Pneumática / Pneumatic / Pneumatique

CLAVO / PREGO / NAIL / CLOU

Holz-Her. 100-160 mm

PRESIÓN / PRESSÃO / PRESSURE / PRESSION

5 - 8 atm

PESO / PESO / WEIGHT / POIDS

6,87 Kg

CAPACIDAD / CAPACIDADE / CAPACITY / CAPACITÉ

56 clavos / pregos / nails / clous



TAMAÑO REAL  
TAMANHO REAL  
ACTUAL SIZE  
TAILLE RÉELLE

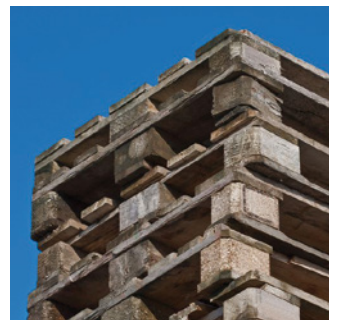

Código	Modelo	Long. mm
Código	Modelo	Comp. mm
Code	Model	Length mm
Code	Modèle	Long. mm

LISO / SMOOTH / LISSE

5005018	1,6 X 18 L	18
5005022	1,6 X 22 L	22
5005025	1,6 X 25 L	25
5005028	1,6 X 28 L	28
5005032	1,6 X 32 L	32

ANILLADO / ANILHADO / RINGED / ANNELÉ

5007018	1,6 x 18 A	18
5007022	1,6 x 22 A	22
5007025	1,6 x 25 A	25
5007028	1,6 x 28 A	28
5007032	1,6 x 32 A	32

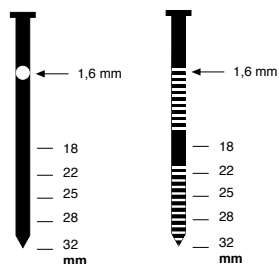

TAMAÑO REAL  
TAMANHO REAL  
ACTUAL SIZE  
TAILLE RÉELLE

ATRO  
BOSTITCH

16  
GAUGE

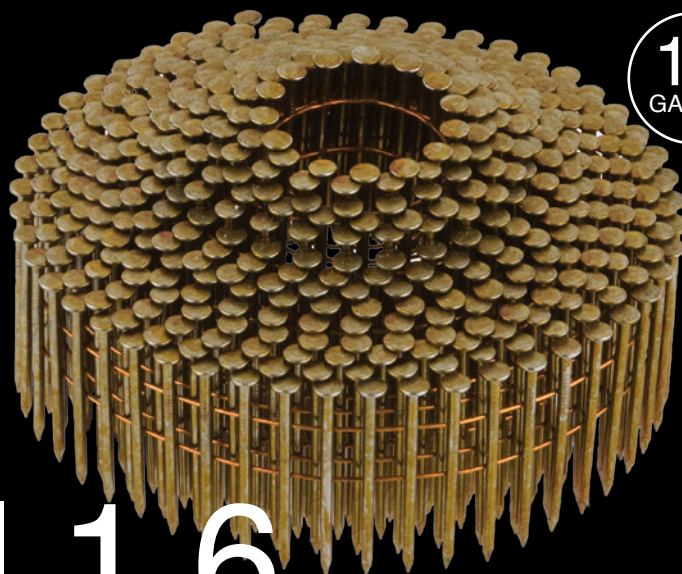

# coil 1,6



EMBALAJE MADERA  
EMBALAGEM DE MADEIRA  
CRATES  
EMBALLAGE EN BOIS



PALETS  
PALLETES  
PALETES  
PALETES



CONSTRUCCIÓN  
CONSTRUÇÃO  
CONSTRUCTION  
CONSTRUCTION



EBANISTERIA Y MUEBLES  
MARCENARIA E MÓVEIS  
JOINERY AND FURNITURE  
MENUISERIE ET MEUBLES



CARPINTERÍA  
CARPINTARIA  
CARPENTRY  
MENUISERIE

- E** Recubrimiento del alambre: básico.
- P** Revestimento de fio: básico.
- UK** Wire coating: basic.
- F** Revêtement du fils: basique.



ATRO  
SENCO  
BOSTITCH  
BEA  
DUOFAST  
HOLZ-HER

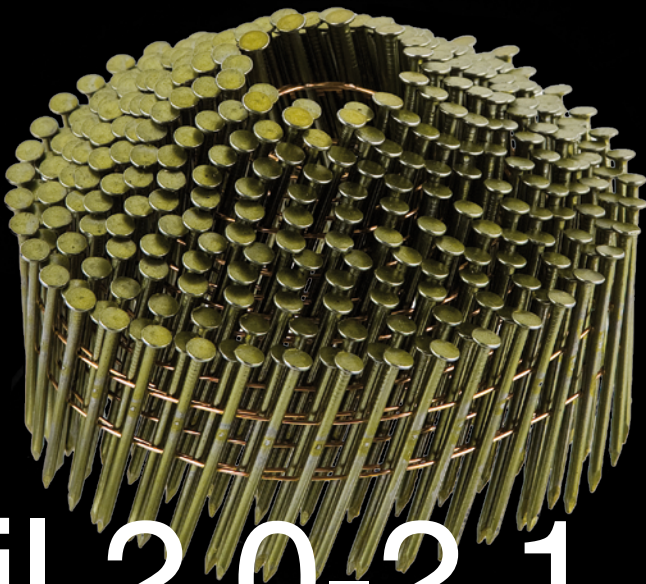

14  
GAUGE

15°  
16°

CLAVOS  
PREGOS  
NAILS  
CLOUS

2

# coil 2,0-2,1



EMBALAJE MADERA  
EMBALAGEM DE MADEIRA  
CRATES  
EMBALLAGE EN BOIS



PALETS  
PALLETS  
PALETTS  
PALETES



CONSTRUCCIÓN  
CONSTRUÇÃO  
CONSTRUCTION  
CONSTRUCTION



EBANISTERIA Y MUEBLES  
MARCENARIA E MÓVEIS  
JOINERY AND FURNITURE  
MENUISERIE ET MUEBLES



CARPINTERÍA  
CARPINTARIA  
CARPENTRY  
MENUISERIE

- E** Recubrimiento del alambre: básico.
- P** Revestimento de fio: básico.
- UK** Wire coating: basic.
- F** Revêtement du fils: basique.

## simC50

1205250

TIPO / TIPO / TYPE / TYPE

Neumática / Pneumática / Pneumatic / Pneumatique

CLAVO / PREGO / NAIL / CLOU

Coil 2,10-2,00. 100-160 mm

PRESIÓN / PRESSÃO / PRESSURE / PRESSION

5 - 8 atm

PESO / PESO / WEIGHT / POIDS

1,9 Kg

CAPACIDAD / CAPACIDADE / CAPACITY / CAPACITÉ

350-400 clavos / pregos / nails / clous

COMPATIBLE CON BOBINAS CÓNICAS

COMPATÍVEL COM BOBINHAS CÔNICAS

COMPATIBLE WITH CONICAL COILS

COMPATIBLE AVEC ROULEAUX CONIQUES



## simC57

1205157

TIPO / TIPO / TYPE / TYPE

Neumática / Pneumática / Pneumatic / Pneumatique

CLAVO / PREGO / NAIL / CLOU

Coil 2,10-2,00. 100-160 mm

PRESIÓN / PRESSÃO / PRESSURE / PRESSION

5 - 8 atm

PESO / PESO / WEIGHT / POIDS

2,7 Kg

CAPACIDAD / CAPACIDADE / CAPACITY / CAPACITÉ

300-350 clavos / pregos / nails / clous

COMPATIBLE CON BOBINAS RECTAS

COMPATÍVEL COM BOBINHAS RETAS

COMPATIBLE WITH STRAIGHT COILS

COMPATIBLE AVEC ROULEAUX DROITES

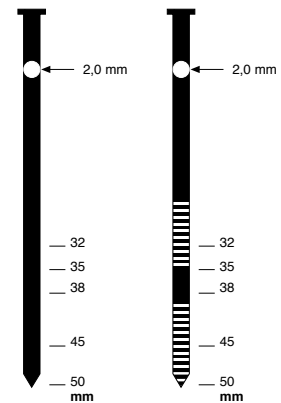

TAMAÑO REAL  
TAMANHO REAL  
ACTUAL SIZE  
TAILLE RÉELLE

Código	Modelo	Long. mm
Código	Modelo	Comp. mm
Code	Model	Length mm
Code	Modèle	Long. mm
LISO / SMOOTH / LISSE		
5005132	2,0 x 32 L	32
5005135	2,0 x 35 L	35
5005138	2,0 x 38 L	38
5005140	2,0 x 40 L	40
5005145	2,0 x 45 L	45
5005150	2,0 x 50 L	50

LISO, BOBINA, 1000 UDS		
LISO, BOBINHA, 1000 UDS		
SMOOTH, COIL, 1000 UNITS		
LISSE, ROULEAU, 1000 UNITÉS		
5005532	2,0 X 32 L B-1000	32
5005136	2,0 X 35 L B-1000	35
5005538	2,0 X 38 L B-1000	38
5005545	2,0 X 45 L B-1000	45
5005153	2,0 X 50 L B-1000	50

ANILLADO / ANILHADO / RINGED / ANNELÉ		
5007028	2,0 x 28 A	28
5007132	2,0 x 32 A	32
5007135	2,0 x 35 A	35
5007138	2,0 x 38 A	38
5007145	2,0 x 45 A	45
5007150	2,0 x 50 A	50
5007155	2,0 x 55 A	55

ANILLADO, BOBINA, 1000 UDS		
ANILHADO, BOBINHA, 1000 UDS		
RINGED, COIL, 1000 UNITS		
ANNELÉ, ROULEAU 1000 UNITÉS		
5007228	2,0 x 28 A B-1000	28
5007238	2,0 x 38 A B-1000	38

PUNTO DIVERGENTE		
PONTO DE DIVERGÊNCIA		
DIVERGENT POINTS		
POINTE DIVERGENTE		
5005332	2,0 X 32 L P D	32
5005338	2,0 X 38 L P D	38
5005340	2,0 X 40 L P D	40
5005345	2,0 X 45 L P D	45
5005350	2,0 X 50 L P D	50

PUNTO DIVERGENTE, BOBINA, 1000 UDS		
PONTO DE DIV, BOBINHA, 1000 UDS		
DIVERGENT POINT, COIL, 1000 UNITS		
POINTE DE DIV, ROULEAU, 1000 UNITÉS		
5005333	2,0 x 32 L P D B-1000	32
5005335	2,0 x 35 L P D B-1000	35
5005341	2,0 x 40 L P D B-1000	40
5005346	2,0 x 45 L P D B-1000	45



2

**CLAVOS  
PREGOS  
NAILS  
CLOUS**

Código	Modelo	Long. mm
Código	Modelo	Comp. mm
Code	Model	Length mm
Code	Modèle	Long. mm

LISO / SMOOTH / LISSE

5001045	2,2 X 45 L	45
5001050	2,2 X 50 L	50
5001055	2,2 X 55 L	55
5001060	2,2 X 60 L	60
5001065	2,2 X 65 L	65

ANILLADO / ANILHADO / RINGED / ANNELÉ

5002045	2,2 x 45 A	45
5002050	2,2 x 50 A	50
5002055	2,2 x 55 A	55
5002060	2,2 x 60 A	60
5002065	2,2 x 65 A	65

ANILLADO, BOBINA, 1200 UDS

ANILHADO, BOBINHA, 1200 UDS

RINGED, COIL, 1200 UNITS

ANNELÉ, ROULEAU 1200 UNITÉS

5002046	2,2 x 45 A B-1200	45
5002051	2,2 x 50 A B-1200	50
5002056	2,2 x 55 A B-1200	55
5002061	2,2 x 60 A B-1200	60
5002066	2,2 x 65 A B-1200	65

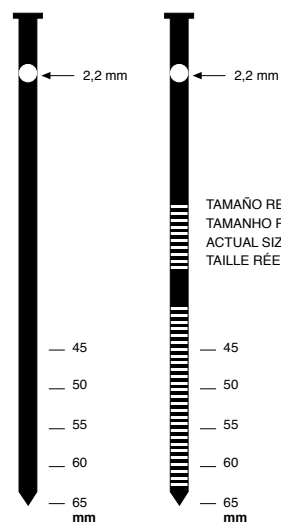
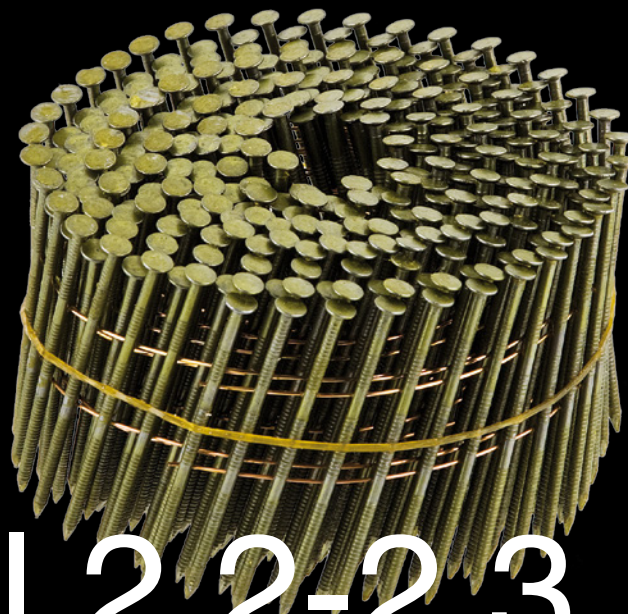
**ATRO  
SENCO  
BOSTITCH  
BEA  
DUOFAST  
HOLZ-HER**
13  
GAUGE15°  
16°

coil 2,2-2,3

**EMBALAJE MADERA  
EMBALAGEM DE MADEIRA  
CRATES  
EMBALLAGE EN BOIS**

**PALETS  
PALLETES  
PALETES**

**CONSTRUCCIÓN  
CONSTRUÇÃO  
CONSTRUCTION  
CONSTRUCTION**

**EBANISTERIA Y MUEBLES  
MARCENARIA E MÓVEIS  
JOINERY AND FURNITURE  
MENUISERIE ET MEUBLES**

**CARPINTERÍA  
CARPINTARIA  
CARPENTRY  
MENUISERIE**
**E** Recubrimiento del alambre: básico.

**P** Revestimento de fio: básico.

**UK** Wire coating: basic.

**F** Revêtement du fils: basique.

### simC57

1205157

TIPO / TIPO / TYPE / TYPE

Neumática / Pneumática / Pneumatic / Pneumatique

CLAVO / PREGO / NAIL / CLOU

Coil 2,20-2,30. 45-57 mm

PRESIÓN / PRESSÃO / PRESSURE / PRESSION

5 - 8 atm

PESO / PESO / WEIGHT / POIDS

2,7 Kg

CAPACIDAD / CAPACIDADE / CAPACITY / CAPACITÉ

300-350 clavos / pregos / nails / clous



### simC65

1205265

TIPO / TIPO / TYPE / TYPE

Neumática / Pneumática / Pneumatic / Pneumatique

CLAVO / PREGO / NAIL / CLOU

Coil 2,20-2,30. 36-65 mm

PRESIÓN / PRESSÃO / PRESSURE / PRESSION

5 - 8 atm

PESO / PESO / WEIGHT / POIDS

2,6 Kg

CAPACIDAD / CAPACIDADE / CAPACITY / CAPACITÉ

300 clavos / pregos / nails / clous



### simC70

1205270

TIPO / TIPO / TYPE / TYPE

Neumática / Pneumática / Pneumatic / Pneumatique

CLAVO / PREGO / NAIL / CLOU

Coil 2,20-2,30. 45-70 mm

PRESIÓN / PRESSÃO / PRESSURE / PRESSION

5 - 8 atm

PESO / PESO / WEIGHT / POIDS

3,6 Kg

CAPACIDAD / CAPACIDADE / CAPACITY / CAPACITÉ

250-300 clavos / pregos / nails / clous



ATRO  
SENCO  
BOSTITCH  
BEA  
DUOFAST  
HOLZ-HER

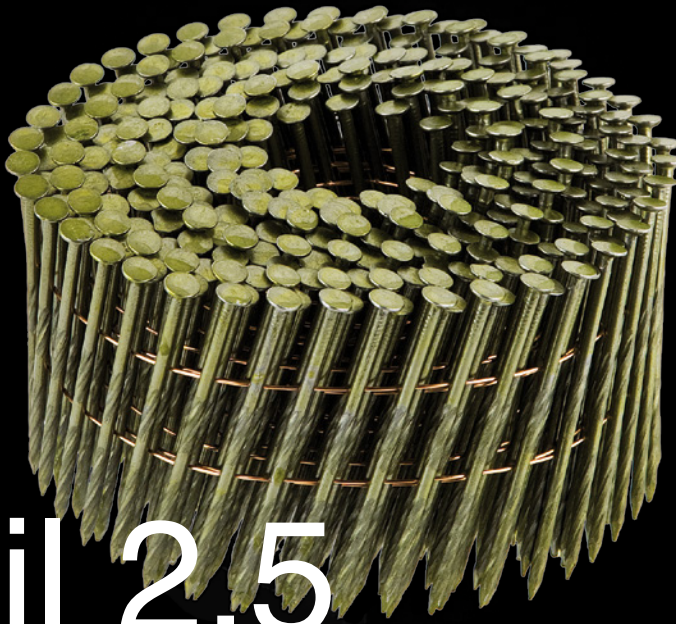

12  
GAUGE

15°  
16°

CLAVOS  
PREGOS  
NAILS  
CLOUS

2

# coil 2,5



EMBALAJE MADERA  
EMBALAGEM DE MADEIRA  
CRATES  
EMBALLAGE EN BOIS



PALETS  
PALLETES  
PALETES  
PALETES



CONSTRUCCIÓN  
CONSTRUÇÃO  
CONSTRUCTION  
CONSTRUCTION



EBANISTERIA Y MUEBLES  
MARCENARIA E MÓVEIS  
JOINERY AND FURNITURE  
MENUISERIE ET MEUBLES



CARPINTERÍA  
CARPINTARIA  
CARPENTRY  
MENUISERIE

- E** Recubrimiento del alambre: básico.
- P** Revestimento de fio: básico.
- UK** Wire coating: basic.
- F** Revêtement du fils: basique.

## simC57

1205157

TIPO / TIPO / TYPE / TYPE  
Neumática / Pneumática  
Pneumatic / Pneumatique

CLAVO / PREGO / NAIL / CLOU  
Coil 2,5. 45-57 mm

PRESIÓN / PRESSÃO  
PRESSURE / PRESSION  
5 - 8 atm

PESO / PESO  
WEIGHT / POIDS  
2,7 Kg

CAPACIDAD / CAPACIDADE  
CAPACITY / CAPACITÉ  
300-350  
clavos / pregos nails / clous



## simC65

1205265

TIPO / TIPO / TYPE / TYPE  
Neumática / Pneumática  
Pneumatic / Pneumatique

CLAVO / PREGO / NAIL / CLOU  
Coil 2,5. 38-65 mm

PRESIÓN / PRESSÃO  
PRESSURE / PRESSION  
5 - 8 atm

PESO / PESO  
WEIGHT / POIDS  
2,6 Kg

CAPACIDAD / CAPACIDADE  
CAPACITY / CAPACITÉ  
300  
clavos / pregos nails / clous



## simC70

1205270

TIPO / TIPO / TYPE / TYPE  
Neumática / Pneumática  
Pneumatic / Pneumatique

CLAVO / PREGO / NAIL / CLOU  
Coil 2,5. 40-70 mm

PRESIÓN / PRESSÃO  
PRESSURE / PRESSION  
5 - 8 atm

PESO / PESO  
WEIGHT / POIDS  
3,6 Kg

CAPACIDAD / CAPACIDADE  
CAPACITY / CAPACITÉ  
200-300  
clavos / pregos nails / clous



## simC90

1205290

TIPO / TIPO / TYPE / TYPE  
Neumática / Pneumática  
Pneumatic / Pneumatique

CLAVO / PREGO / NAIL / CLOU  
Coil 2,5. 38-90 mm

PRESIÓN / PRESSÃO  
PRESSURE / PRESSION  
5 - 8 atm

PESO / PESO  
WEIGHT / POIDS  
3,6 Kg

CAPACIDAD / CAPACIDADE  
CAPACITY / CAPACITÉ  
200-300  
clavos / pregos nails / clous



Código	Modelo	Long. mm
Código	Modelo	Comp. mm
Code	Model	Length mm
Code	Modèle	Long. mm

LISO / SMOOTH / LISSE

5000350	2,5 X 50 L	50
5000355	2,5 X 55 L	55
5000360	2,5 X 60 L	60
5000365	2,5 X 65 L	65
5000370	2,5 X 70 L	70
5000375	2,5 X 75 L	75

ROSCADO BOBINA

ROSCADO BOBINHA

SCREW COIL

TORSADÉ ROULEAU

5001350	2,5 x 50 H.	50
5001355	2,5 x 55 H.	55
5001360	2,5 x 60 H.	60
5001365	2,5 x 65 H.	65
5001370	2,5 x 70 H.	70
5001375	2,5 x 75 H.	75

ROSCADO, BOBINA, 1000 UDS

ROSCADO, BOBINHA, 1000 UDS

SCREW, COIL, 1000 UNITS

TORSADÉ, ROULEAU, 1000 UNITÉS

5001351	2,5 x 50 H B-1000	50
5001356	2,5 x 55 H B-1000	55
5001361	2,5 x 60 H B-1000	60
5001366	2,5 x 65 H B-1000	65
5001371	2,5 x 70 H B-1000	70
5001376	2,5 x 75 H B-1000	75

ANILLADO / ANILHADO / RINGED / ANELÉ

5007350	2,5 x 50 A	50
5007355	2,5 x 55 A	55
5007360	2,5 x 60 A	60
5007365	2,5 x 65 A	65
5007370	2,5 x 70 A	70
5007375	2,5 x 75 A	75

TAMAÑO REAL / TAMANHO REAL  
ACTUAL SIZE / TAILLE RÉELLE

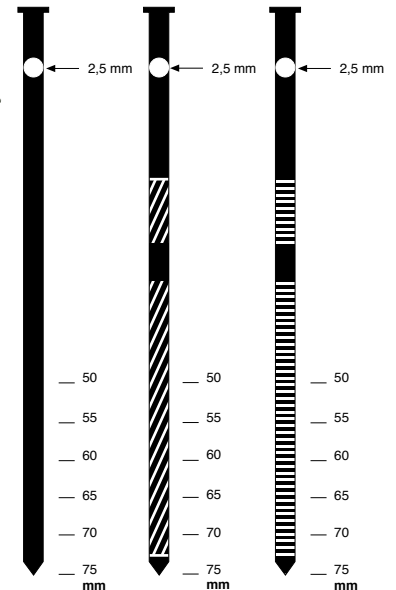

2

**CLAVOS  
PREGOS  
NAILS  
CLOUS**

Código	Modelo	Long. mm
Código	Modelo	Comp. mm
Code	Model	Length mm
Code	Modèle	Long. mm

LISO / SMOOTH /

5005460	2,9 x 60 L	60
5005465	2,9 x 65 L	65
5005470	2,9 x 70 L	70
5005475	2,9 x 75 L	75
5005480	2,9 x 80 L	80
5005490	2,9 x 90 L	90

ROSCADO / SCREW / TORSADÉ

5007460	2,9 X 60 H	60
5007465	2,9 X 65 H	65
5007470	2,9 X 70 H	70
5007475	2,9 X 75 H	75
5007480	2,9 X 80 H	80
5007490	2,9 X 90 H	90

ROSCADO, BOBINA, 900 UDS

ROSCADO, BOBINHA, 900 UDS

SCREW, COIL, 900 UNITS

TORSADÉ, ROULEAU, 900 UNITÉS

5007467	2,9 x 65 H B-900	55
5007471	2,9 x 70 H B-900	60
5007481	2,9 x 80 H B-900	65

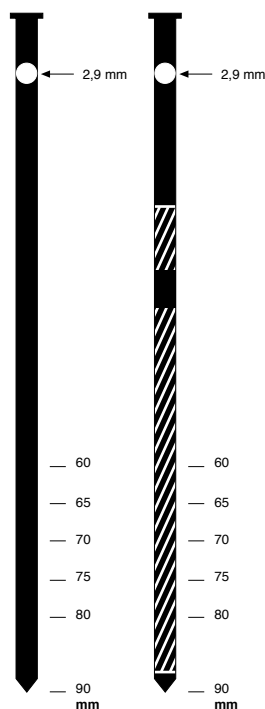

TAMAÑO REAL  
TAMANHO REAL  
ACTUAL SIZE  
TAILLE RÉELLE



ATRO  
SENCO  
BOSTITCH  
BEA  
DUOFAST  
HOLZ-HER

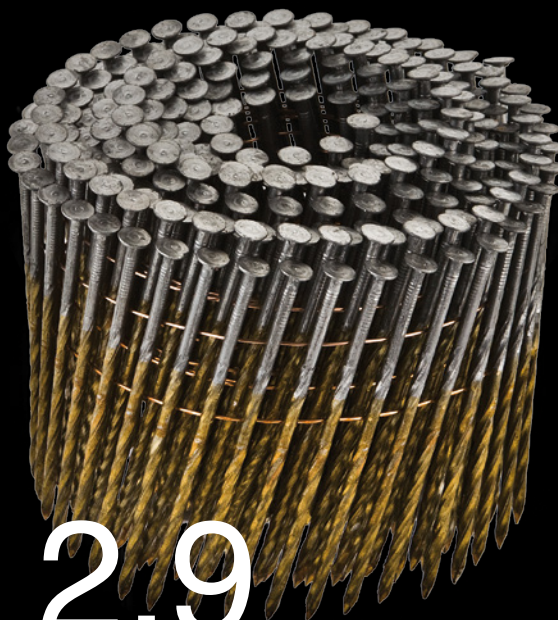

# coil 2,9

11  
GAUGE15°  
16°

EMBALAJE MADERA  
EMBALAGEM DE MADEIRA  
CRATES  
EMBALLAGE EN BOIS



PALETS  
PALLETES  
PALETES  
PALETES



CONSTRUCCIÓN  
CONSTRUÇÃO  
CONSTRUCTION  
CONSTRUCTION



EBANISTERIA Y MUEBLES  
MARCENARIA E MÓVEIS  
JOINERY AND FURNITURE  
MENUISERIE ET MEUBLES



CARPINTERÍA  
CARPINTARIA  
CARPENTRY  
MENUISERIE

**E** Recubrimiento del alambre: básico.

**P** Revestimento de fio: básico.

**UK** Wire coating: basic.

**F** Revêtement du fils: basique.

## simC70

1205270

TIPO / TIPO / TYPE / TYPE

Neumática / Pneumática / Pneumatic / Pneumatique

CLAVO / PREGO / NAIL / CLOU

Coil 2,9. 45-70 mm

PRESIÓN / PRESSÃO / PRESSURE / PRESSION

5 - 8 atm

PESO / PESO / WEIGHT / POIDS

3,6 Kg

CAPACIDAD / CAPACIDADE / CAPACITY / CAPACITÉ

280-300 clavos / pregos / nails / clous



## simC90

1205290

TIPO / TIPO / TYPE / TYPE

Neumática / Pneumática / Pneumatic / Pneumatique

CLAVO / PREGO / NAIL / CLOU

Coil 2,9. 38-90 mm

PRESIÓN / PRESSÃO / PRESSURE / PRESSION

5 - 8 atm

PESO / PESO / WEIGHT / POIDS

3,6 Kg

CAPACIDAD / CAPACIDADE / CAPACITY / CAPACITÉ

280-300 clavos / pregos / nails / clous





ATRO  
SENCO  
BOSTITCH  
BEA  
DUOFAST  
HOLZ-HER



11  
GAUGE

15°  
16°

coil 3,1

CLAVOS  
PREGOS  
NAILS  
CLOUS

2

Código	Modelo	Long. mm
Código	Modelo	Comp. mm
Code	Model	Length mm
Code	Modèle	Long. mm

ROSCADO / SCREW / TORSADE		
5009270	3,1 X 70 H	70
5009275	3,1 X 75 H	75
5009280	3,1 X 80 H	80
5009290	3,1 X 90 H	90
ANILLADO / ANILHADO / RINGED / ANNELE		
5003170	3,1 x 70 A	70
5003175	3,1 x 75 A	75
5003180	3,1 x 80 A	80
5003190	3,1 x 90 A	90

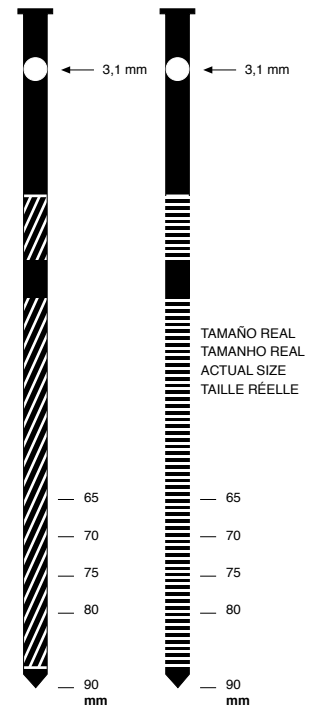

EMBALAJE MADERA  
EMBALAGEM DE MADEIRA  
CRATES  
EMBALLAGE EN BOIS



PALETS  
PALLETS  
PALETTES  
PALETTES



CONSTRUCCIÓN  
CONSTRUÇÃO  
CONSTRUCTION  
CONSTRUCTION



EBANISTERIA Y MUEBLES  
MARCENARIA E MÓVEIS  
JOINERY AND FURNITURE  
MENUISERIE ET MEUBLES



CARPINTERÍA  
CARPINTARIA  
CARPENTRY  
MENUISERIE

- E** Recubrimiento del alambre: básico.
- P** Revestimento de fio: básico.
- UK** Wire coating: basic.
- F** Revêtement du fils: basique.

## simC90

1205290

TIPO / TIPO / TYPE / TYPE

Neumática / Pneumática / Pneumatic / Pneumatique

CLAVO / PREGO / NAIL / CLOU

Coil 3,1. 38-90 mm

PRESIÓN / PRESSÃO / PRESSURE / PRESSION

5 - 8 atm

PESO / PESO / WEIGHT / POIDS

3,6 Kg

CAPACIDAD / CAPACIDADE / CAPACITY / CAPACITÉ

200-300 clavos / pregos / nails / clous



Código	Modelo	Long. mm
Código	Modelo	Comp. mm
Code	Model	Length mm
Code	Modèle	Long. mm

## LISO / SMOOTH / LISSE

5009010	3,8 x 100 L.	100
5009011	3,8 x 110 L.	110
5009012	3,8 x 120 L.	120
5009013	3,8 x 130 L.	130

## ROSCADO / SCREW / TORSADÉ

5009100	3,8 x 100 H.	100
5009110	3,8 x 110 H.	110
5009120	3,8 x 120 H.	120
5009130	3,8 x 130 H.	130

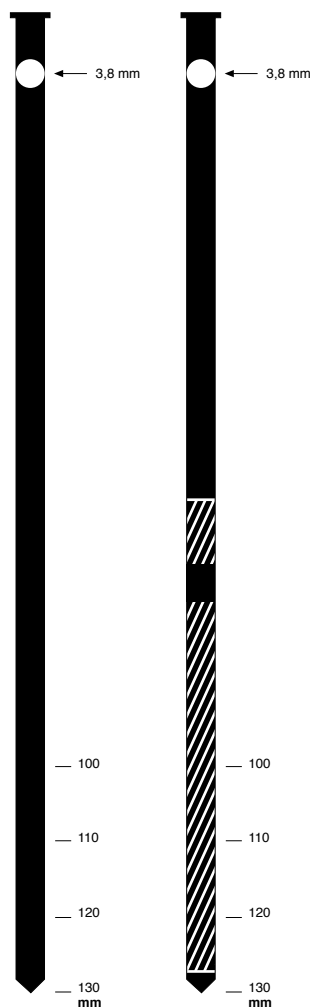

TAMAÑO REAL  
TAMANHO REAL  
ACTUAL SIZE  
TAILLE RÉELLE



ATRO  
SENCO  
BOSTITCH  
BEA  
DUOFAST  
HOLZ-HER

9  
GAUGE

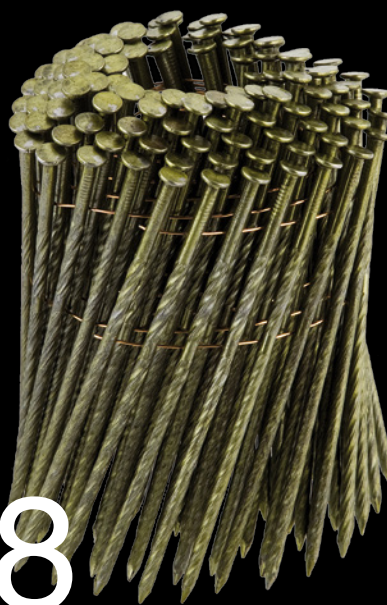

# coil 3,8



EMBALAJE MADERA  
EMBALAGEM DE MADEIRA  
CRATES  
EMBALLAGE EN BOIS



PALETS  
PALLETES  
PALETTS  
PALETTES



CONSTRUCCIÓN  
CONSTRUÇÃO  
CONSTRUCTION  
CONSTRUCTION



EBANISTERIA Y MUEBLES  
MARCENARIA E MÓVEIS  
JOINERY AND FURNITURE  
MENUISERIE ET MEUBLES



CARPINTERÍA  
CARPINTARIA  
CARPENTRY  
MENUISERIE

- E** Recubrimiento del alambre: básico.
- P** Revestimento de fio: básico.
- UK** Wire coating: basic.
- F** Revêtement du fil: basique.

## simC130

1205230

TIPO / TIPO / TYPE / TYPE

Neumática / Pneumática / Pneumatic / Pneumatique

CLAVO / PREGO / NAIL / CLOU

Coil 3,8. 75-130 mm

PRESIÓN / PRESSÃO / PRESSURE / PRESSION

5 - 8 atm

PESO / PESO / WEIGHT / POIDS

5,79 Kg

CAPACIDAD / CAPACIDADE / CAPACITY / CAPACITÉ

120-225 clavos / pregos / nails / clous



## Hojas de sierra para recuperadores de palets Lâminas de serra para recicladores de paletes Saw blades for pallet recyclers Les lames de scie pour les recycleurs de palettes

CARACTERÍSTICAS / CHARACTERISTICS / CARACTÉRISTIQUES

10-14 dientes/pulgada

10-14 dentes/polegada

10-14 teeth/inch

10-14 dent /pouce

Código	Modelo	Long. mm	Embalaje
Código	Modelo	Comp. mm	Acondicionamento
Code	Model	Length mm	Packaging
Code	Modèle	Long. mm	Emballage

48020010	HOJA SIERRA BIMETAL 200 mm 10/14 TPI	200	250
48022510	HOJA SIERRA BIMETAL 225 mm 10/14 TPI	225	50
48030010	HOJA SIERRA BIMETAL 300 mm 10/14 TPI	300	50



11  
GAUGE

CLAVOS  
PREGOS  
NAILS  
CLOUS

2

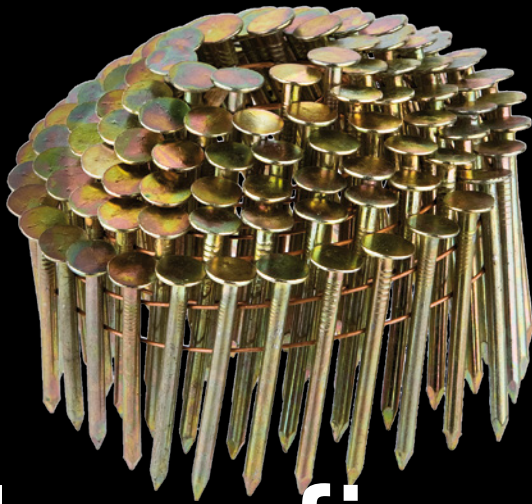

# coil roofing

Código Código Code Code	Modelo Modelo Model Modèle	Long. mm Comp. mm Length mm Long. mm
3303111	3,1 x 20 L.	20
3303112	3,1 x 22 L.	22
3303113	3,1 x 25 L.	25
3303115	3,1 x 32 L.	32
3303138	3,1 x 38 L.	38

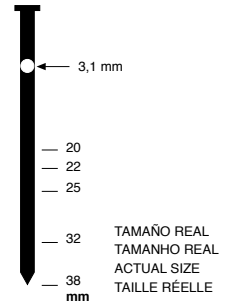

- E** Recubrimiento del alambre: bicromatado.
- P** Revestimento de fio: dicromato.
- UK** Wire coating: dichromate.
- F** Revêtement du fils: dichromate.

## RoofPro 455XP 1200240

TIPO / TIPO / TYPE / TYPE  
Neumática / Pneumática / Pneumatic / Pneumatique  
CLAVO / PREGO / NAIL / CLOU  
Coil Roofing 19-45 mm  
PRESIÓN / PRESSÃO / PRESSURE / PRESSION  
5 - 8 atm  
PESO / PESO / WEIGHT / POIDS  
2,68 Kg  
CAPACIDAD / CAPACIDADE / CAPACITY / CAPACITÉ  
120 clavos / pregos / nails / clous







**ANILLADAS**  
**ANILHADOS**  
**HOG RINGS**  
**ANNELÉES**

mod HR	54
mod RT	55
mod YM13	56
mod CL23	56
mod C20	57
mod CL12	58
mod YK11	59
mod C17	60
mod A18 coil / mod A19 coil	61
mod A20	62
mod A18 / A16	64
omega 20 / omega 16	66
mod A40	68
mod CL25	69
mod G29 / mod G35	70
mod CL50	72
Grampillones	73
PREGOS U	
U-NAILS	
GRAMPILLONS	

Código	Modelo	Long. mm
Código	Modelo	Comp. mm
Code	Model	Length mm
Code	Modèle	Long. mm

BÁSICO / BASIC / BASE

4360050	HR14	8
4360102	HR16	8
4360168	HR20	10
4360245	HR22	12
4360254	HR30	14

GALVANIZADO / GALVANIZED / GALVANISÉ

4360080	HR14	8
4360244	HR16	8
4360265	HR20	10
4360241	HR22	12
4360275	HR30	14

GALVANIZADO, BLISTER 1.000 UDS  
GALVANIZED, BLISTER 1000 UNITS  
GALVANISÉ, BLISTER 1000 UNITÉS

4360251 HR2

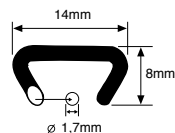

HR-14

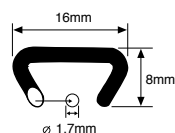
17  
GAUGE

HR-16

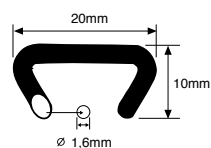
17  
GAUGE

HR-20

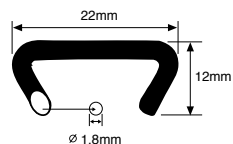
16  
GAUGE

HR-22

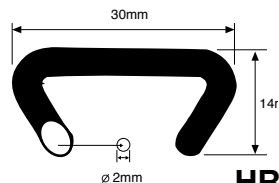
15  
GAUGE

HR-30

14  
GAUGETAMAÑO REAL  
TAMANHO REAL  
ACTUAL SIZE  
TAILLE RÉELLE

mod HR

CERCADOS, JAULAS E INVERNADEROS  
CERCAS, GAIOLAS E ESTUFAS  
FENCES, CAGES AND GREENHOUSES  
CLÔTURES, CAGES ET SERRESCOLCHONERIA  
COLCHÕES  
MATTRESSES  
MATELASINDÚSTRIA GERAL  
INDÚSTRIA EM GERAL  
GENERAL INDUSTRY  
L'INDUSTRIE EN GÉNÉRALCIERRE DE BOLSAS  
FECHAR SACOS  
BAG CLOSERS  
FERMETURE DE SACSINDÚSTRIA AUTOMÓVIL  
INDÚSTRIA AUTOMÓVEL  
AUTOMOTIVE INDUSTRY  
INDUSTRIE AUTOMOBILE

E Recubrimiento del alambre: galvanizado, básico.

P Revestimento de fio: galvanizado, básico.

UK Wire coating: galvanized, basic.

F Revêtement du fil: galvanisé, base.

HR 60-14

3200056

TIPO / TIPO / TYPE / TYPE

Neumática / Pneumática / Pneumatic / Pneumatique

GRAPA / AGRAFO / STAPLE / AGRAFE

HR-14

PRESIÓN / PRESSÃO / PRESSURE / PRESSION

4 - 7 atm

PESO / PESO / WEIGHT / POIDS

1,87 Kg

CAPACIDAD / CAPACIDADE

CAPACITY / CAPACITÉ

53 grapas / agrafos

staples / agrafes

simes



HR 60-16

3200072

TIPO / TIPO / TYPE / TYPE

Neumática / Pneumática / Pneumatic / Pneumatique

GRAPA / AGRAFO / STAPLE / AGRAFE

HR-16

PRESIÓN / PRESSÃO / PRESSURE / PRESSION

4 - 7 atm

PESO / PESO / WEIGHT / POIDS

1,90 Kg

CAPACIDAD / CAPACIDADE

CAPACITY / CAPACITÉ

53 grapas / agrafos

staples / agrafes

simes



HR 60-20

3200098

TIPO / TIPO / TYPE / TYPE

Neumática / Pneumática / Pneumatic / Pneumatique

GRAPA / AGRAFO / STAPLE / AGRAFE

HR-20

PRESIÓN / PRESSÃO / PRESSURE / PRESSION

4 - 7 atm

PESO / PESO / WEIGHT / POIDS

1,93 Kg

CAPACIDAD / CAPACIDADE

CAPACITY / CAPACITÉ

53 grapas / agrafos

staples / agrafes

simes



Simes 88

1130088

TIPO / TIPO / TYPE / TYPE

Neumática / Pneumática / Pneumatic / Pneumatique

GRAPA / AGRAFO / STAPLE / AGRAFE

HR-22

PRESIÓN / PRESSÃO / PRESSURE / PRESSION

5 - 7 atm

PESO / PESO / WEIGHT / POIDS

1,43 Kg

CAPACIDAD / CAPACIDADE

CAPACITY / CAPACITÉ

130 grapas / agrafos

staples / agrafes

simes



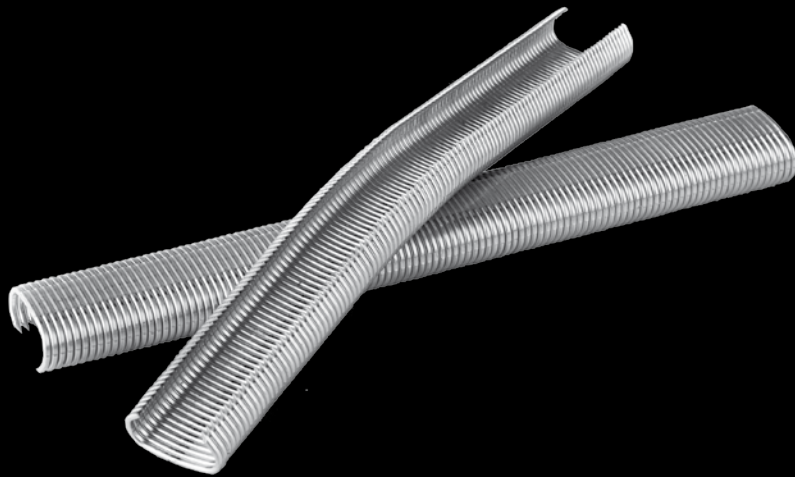

15  
GAUGE

# mod RT

ANILLADAS  
ANILHADOS  
HOG RINGS  
ANNELÉES **3**

Código Código Code Code	Modelo Modelo Model Modèle	Long. mm Comp. mm Length mm Long. mm
4490454	RT-23	12
4490460	RT-23B	12

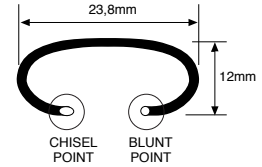

TAMAÑO REAL  
TAMANHO REAL  
ACTUAL SIZE  
TAILLE RÉELLE



COLCHONERÍA  
COLCHÕES  
MATTRESSES  
MATELAS



INDÚSTRIA GENERAL  
INDÚSTRIA EM GERAL  
GENERAL INDUSTRY  
L'INDUSTRIE EN GÉNÉRAL



CIERRE DE BOLSAS  
FECHAR SACOS  
BAG CLOSERS  
FERMETURE DE SACS



INDÚSTRIA AUTOMÓVIL  
INDÚSTRIA AUTOMÓVEL  
AUTOMOTIVE INDUSTRY  
INDUSTRIE AUTOMOBILE

- E** Recubrimiento del alambre: galvanizado.
- P** Revestimento de fio: galvanizado.
- UK** Wire coating: galvanized.
- F** Revêtement du fils: galvanisé.

## Simes 80 1130080

MORRO CORTO / BICO CURTO  
SHORT NOSE / NEZ COURTE 46mm

TIPO / TIPO / TYPE / TYPE

Neumática / Pneumática / Pneumatic / Pneumatique

GRAPA / AGRAFO / STAPLE / AGRAFE RT23 / RT23B

PRESIÓN / PRESSÃO / PRESSURE / PRESSION 5 - 7 atm

PESO / PESO / WEIGHT / POIDS 1,48 Kg

CAPACIDAD / CAPACIDADE / CAPACITY / CAPACITÉ

130 grapas / agrafos staples / agrafes



**simes**

7,8mm

## Simes 81 1130081

MORRO CORTO / BICO CURTO  
SHORT NOSE / NEZ COURTE 46mm

TIPO / TIPO / TYPE / TYPE

Neumática / Pneumática / Pneumatic / Pneumatique

GRAPA / AGRAFO / STAPLE / AGRAFE RT23 / RT23B

PRESIÓN / PRESSÃO / PRESSURE / PRESSION 5 - 7 atm

PESO / PESO / WEIGHT / POIDS 1,48 Kg

CAPACIDAD / CAPACIDADE / CAPACITY / CAPACITÉ

130 grapas / agrafos staples / agrafes



**simes**

4,7mm

## Simes 82 1130082

MORRO MEDIO / BICO MÉDIO  
MEDIUM NOSE / NEZ MOYEN 61mm

TIPO / TIPO / TYPE / TYPE

Neumática / Pneumática / Pneumatic / Pneumatique

GRAPA / AGRAFO / STAPLE / AGRAFE RT23 / RT23B

PRESIÓN / PRESSÃO / PRESSURE / PRESSION 5 - 7 atm

PESO / PESO / WEIGHT / POIDS 1,50 Kg

CAPACIDAD / CAPACIDADE / CAPACITY / CAPACITÉ

130 grapas / agrafos staples / agrafes



**simes**

8,2mm

## Simes 83 1130083

MORRO LARGO / BICO LONGO  
LONG NOSE / NEZ LONG 80mm

TIPO / TIPO / TYPE / TYPE

Neumática / Pneumática / Pneumatic / Pneumatique

GRAPA / AGRAFO / STAPLE / AGRAFE RT23 / RT23B

PRESIÓN / PRESSÃO / PRESSURE / PRESSION 5 - 7 atm

PESO / PESO / WEIGHT / POIDS 1,60 Kg

CAPACIDAD / CAPACIDADE / CAPACITY / CAPACITÉ

130 grapas / agrafos staples / agrafes



**simes**

8,2mm



3

**ANILLADAS  
ANILHADOS  
HOG RINGS  
ANNELÉES**

Código	Modelo	Long. mm
Código	Modelo	Comp. mm
Code	Model	Length mm
Code	Modèle	Long. mm

4490990	YM13 Galvanizado	12
	YM13 Galvanizado	
	YM13 Galvanisé	

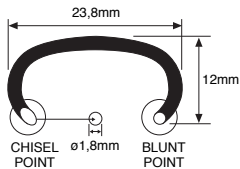

TAMAÑO REAL  
TAMANHO REAL  
ACTUAL SIZE  
TAILLE RÉELLE

BOSTITCH 16G100

15  
GAUGE

# mod YM13



COLCHONERÍA  
COLCHÕES  
MATTRESSES  
MATELAS



INDUSTRIA AUTOMÓVIL  
INDÚSTRIA AUTOMÓVEL  
AUTOMOTIVE INDUSTRY  
INDUSTRIE AUTOMOBILE



CIERRE DE BOLSAS  
FECHAR SACOS  
BAG CLOSERS  
FERMETURE DE SACS



INDÚSTRIA GENERAL  
INDÚSTRIA EM GERAL  
GENERAL INDUSTRY  
L'INDUSTRIE EN GÉNÉRAL



JAUHAS DE ANIMALES  
JAUHAS DE ANIMAIS  
ANIMAL CAGES  
CAGES POUR ANIMAUX



CERCADOS, E INVERNADEROS  
CERCAS E ESTUFAS  
FENCES AND GREENHOUSES  
CLÔTURES ET SERRES



BARCOS  
BARCOS  
BOATS  
BATEAUX

**E** Recubrimiento del alambre: galvanizado.

**P** Revestimento de fio: galvanizado.

**UK** Wire coating: galvanized.

**F** Revêtement du fils: galvanisé.

Código	Modelo	Long. mm
Código	Modelo	Comp. mm
Code	Model	Length mm
Code	Modèle	Long. mm

4490471	CL23 Galvanizado	12
	CL23 Galvanizado	
	CL23 Galvanisé	

BLUNT POINT

4490438	CL23 Galvanizado	12
	CL23 Galvanizado	
	CL23 Galvanisé	

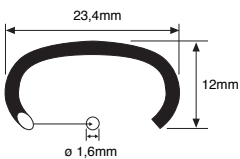

TAMAÑO REAL  
TAMANHO REAL  
ACTUAL SIZE  
TAILLE RÉELLE

BOSTITCH 516G100

16  
GAUGE

# mod CL23



COLCHONERÍA  
COLCHÕES  
MATTRESSES  
MATELAS



INDUSTRIA AUTOMÓVIL  
INDÚSTRIA AUTOMÓVEL  
AUTOMOTIVE INDUSTRY  
INDUSTRIE AUTOMOBILE



CIERRE DE BOLSAS  
FECHAR SACOS  
BAG CLOSERS  
FERMETURE DE SACS



INDÚSTRIA GENERAL  
INDÚSTRIA EM GERAL  
GENERAL INDUSTRY  
L'INDUSTRIE EN GÉNÉRAL



JAUHAS DE ANIMALES  
JAUHAS DE ANIMAIS  
ANIMAL CAGES  
CAGES POUR ANIMAUX



CERCADOS, E INVERNADEROS  
CERCAS E ESTUFAS  
FENCES AND GREENHOUSES  
CLÔTURES ET SERRES



BARCOS  
BARCOS  
BOATS  
BATEAUX

**E** Recubrimiento del alambre: galvanizado, acero inoxidable AISI 316.

**P** Revestimento de fio: galvanizado, aço inoxidável AISI 316.

**UK** Wire coating: galvanized, stainless steel AISI 316.

**F** Revêtement du fils: galvanisé, acier inoxydable AISI 316.





16  
GAUGE

ANILLADAS  
ANILHADOS  
HOG RINGS  
ANNELÉES

3

# mod C20



COLCHONERÍA  
COLCHÕES  
MATTRESSES  
MATELAS



INDUSTRIA AUTOMÓVIL  
INDÚSTRIA AUTOMÓVEL  
AUTOMOTIVE INDUSTRY  
INDUSTRIE AUTOMOBILE



CIERRE DE BOLSAS  
FECHAR SACOS  
BAG CLOSERS  
FERMETURE DE SACS



INDUSTRIA GENERAL  
INDÚSTRIA EM GERAL  
GENERAL INDUSTRY  
L'INDUSTRIE EN GÉNÉRAL



JAUHAS DE ANIMAIS  
JAULAS DE ANIMAIS  
ANIMAL CAGES  
CAGES POUR ANIMAUX



CERCADOS, E INVERNADEROS  
CERCAS E ESTUFAS  
FENCES AND GREENHOUSES  
CLÔTURES ET SERRES



BARCOS  
BARCOS  
BOATS  
BATEAUX

- E** Recubrimiento del alambre: básico, galvanizado, acero inoxidable AISI 316.
- P** Revestimento de fio: básico, galvanizado, aço inoxidável AISI 316.
- UK** Wire coating: basic, galvanized, stainless steel AISI 316.
- F** Revêtement du fil: basique, galvanisé, acier inoxydable AISI 316.

## HR 98 C20

3200195

TIPO / TIPO / TYPE / TYPE

Neumática / Pneumática / Pneumatic / Pneumatique

GRAPA / AGRAFO / STAPLE / AGRAFE

mod C20

PRESIÓN / PRESSÃO / PRESSURE / PRESSION

4 - 7 atm



**simes**

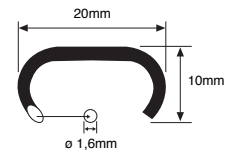

TAMAÑO REAL  
TAMANHO REAL  
ACTUAL SIZE  
TAILLE RÉELLE



**simes**

57

Código	Modelo	Long. mm
Código	Modelo	Comp. mm
Code	Model	Length mm
Code	Modèle	Long. mm

4490425	CL12 Galvanizado	8,7
	CL12 Galvanized	
	CL12 Galvanisé	

4490432	CL12 Acero inoxidable 8,7	
	CL12 Aço inoxidável	
	CL12 Stainless steel	
	CL12 Acier inoxydable	

BLUNT POINT

-	CL12 Galvanizado	8,7
	CL12 Galvanized	
	CL12 Galvanisé	

4490434	CL12 Acero inoxidable 8,7	
	CL12 Aço inoxidável	
	CL12 Stainless steel	
	CL12 Acier inoxydable	

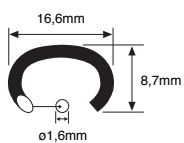

TAMAÑO REAL  
TAMANHO REAL  
ACTUAL SIZE  
TAILLE RÉELLE

BOSTITCH 516G100

**16  
GAUGE**

# mod CL12



COLCHONERÍA  
COLCHÕES  
MATTRESSES  
MATELAS



INDUSTRIA AUTOMÓVIL  
INDÚSTRIA AUTOMÓVEL  
AUTOMOTIVE INDUSTRY  
INDUSTRIE AUTOMOBILE



CIERRE DE BOLSAS  
FECHAR SACOS  
BAG CLOSERS  
FERMETURE DE SACS



INDUSTRIA GENERAL  
INDÚSTRIA EM GERAL  
GENERAL INDUSTRY  
L'INDUSTRIE EN GÉNÉRAL



JAUHAS DE ANIMAIS  
JAULAS DE ANIMAIS  
ANIMAL CAGES  
CAGES POUR ANIMAUX



CERCADOS, E INVERNADEROS  
CERCAS E ESTUFAS  
FENCES AND GREENHOUSES  
CLÔTURES ET SERRES



BARCOS  
BARCOS  
BOATS  
BATEAUX

- E** Recubrimiento del alambre: galvanizado, acero inoxidable AISI 316.
- P** Revestimento de fio: galvanizado, aço inoxidável AISI 316.
- UK** Wire coating: galvanized, stainless steel AISI 316.
- F** Revêtement du fil: galvanisé, acier inoxydable AISI 316.

## Simes 86 1130086

MORRO CORTO / BICO CURTO  
SHORT NOSE / NEZ COURTE 46mm

TIPO / TIPO / TYPE / TYPE

Neumática / Pneumática / Pneumatic / Pneumatique

GRAPA / AGRAFO / STAPLE / AGRAFE CL12

PRESIÓN / PRESSÃO / PRESSURE / PRESSION 5 - 7 atm

PESO / PESO / WEIGHT / POIDS 1,48 Kg

CAPACIDAD / CAPACIDADE / CAPACITY / CAPACITÉ

130 grapas / agrafos staples / agrafes

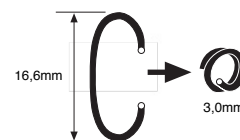



16  
GAUGE

ANILLADAS  
ANILHADOS  
HOG RINGS  
ANNELÉES

3

# mod YK11

Código	Modelo	Long. mm
Código	Modelo	Comp. mm
Code	Model	Length mm
Code	Modèle	Long. mm
4490982	YK11 Galvanizado	10
	YK11 Galvanized	
	YK11 Galvnisé	
4490970	YK11 Stanox	10

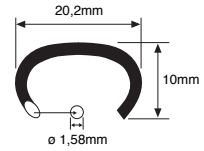

TAMAÑO REAL  
TAMANHO REAL  
ACTUAL SIZE  
TAILLE RÉELLE



COLCHONERÍA  
COLCHÕES  
MATTRESSES  
MATELAS



INDUSTRIA AUTOMÓVIL  
INDÚSTRIA AUTOMÓVEL  
AUTOMOTIVE INDUSTRY  
INDUSTRIE AUTOMOBILE



CIERRE DE BOLSAS  
FECHAR SACOS  
BAG CLOSERS  
FERMETURE DE SACS



INDUSTRIA GENERAL  
INDÚSTRIA EM GERAL  
GENERAL INDUSTRY  
L'INDUSTRIE EN GÉNÉRAL



JAUHAS DE ANIMALES  
JAUHAS DE ANIMAIS  
ANIMAL CAGES  
CAGES POUR ANIMAUX



CERCADOS, E INVERNADEROS  
CERCAS E ESTUFAS  
FENCES AND GREENHOUSES  
CLÔTURES ET SERRES



BARCOS  
BARCOS  
BOATS  
BATEAUX

- E** Recubrimiento del alambre: galvanizado, Stanox.
- P** Revestimento de fio: galvanizado, Stanox.
- UK** Wire coating: galvanized, Stanox.
- F** Revêtement du fils: galvanisé, Stanox.

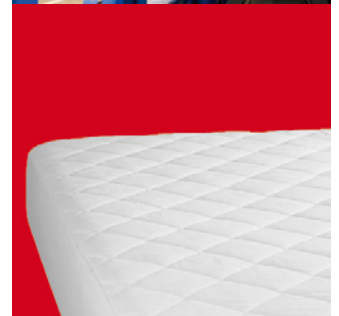

3

**ANILLADAS  
ANILHADOS  
HOG RINGS  
ANNELÉES**

Código	Modelo	Long. mm
Código	Modelo	Comp. mm
Code	Model	Length mm
Code	Modèle	Long. mm
4490420	C17 Galvanizado	8,5
	C17 Galvanizado	
	C17 Galvanisé	

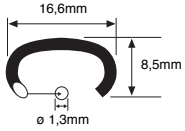

TAMAÑO REAL  
TAMANHO REAL  
ACTUAL SIZE  
TAILLE RÉELLE



**17**  
GAUGE

# mod C17



COLCHONERÍA  
COLCHÕES  
MATTRESSES  
MATELAS



INDUSTRIA AUTOMÓVIL  
INDÚSTRIA AUTOMÓVEL  
AUTOMOTIVE INDUSTRY  
INDUSTRIE AUTOMOBILE



CIERRE DE BOLSAS  
FECHAR SACOS  
BAG CLOSERS  
FERMETURE DE SACS



INDUSTRIA GENERAL  
INDÚSTRIA EM GERAL  
GENERAL INDUSTRY  
L'INDUSTRIE EN GÉNÉRAL



JAUHAS DE ANIMALES  
JAULAS DE ANIMAIS  
ANIMAL CAGES  
CAGES POUR ANIMAUX



CERCADOS, E INVERNADEROS  
CERCAS E ESTUFAS  
FENCES AND GREENHOUSES  
CLÔTURES ET SERRES



BARCOS  
BARCOS  
BOATS  
BATEAUX

- E** Recubrimiento del alambre: galvanizado.
- P** Revestimento de fio: galvanizado.
- UK** Wire coating: galvanized.
- F** Revêtement du fil: galvanisé.

## HR 98 C17 3200200

TIPO / TIPO / TYPE / TYPE

Neumática / Pneumática / Pneumatic / Pneumatique

GRAPA / AGRAFO / STAPLE / AGRAFE

C17

PRESIÓN / PRESSÃO / PRESSURE / PRESSION

4 - 7 atm



**simes**

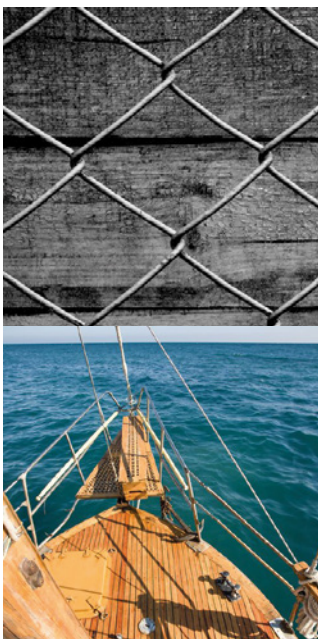



# mod A18 coil mod A19 coil

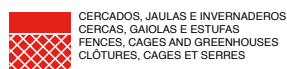

- E** Recubrimiento del alambre: básico, galvanizado.
- P** Revestimento de fio: básico, galvanizado.
- UK** Wire coating: basic, galvanized.
- F** Revêtement de fil: base, galvanisé.

## mod 64 3200090

TIPO / TIPO / TYPE / TYPE  
Neumática / Pneumática / Pneumatic / Pneumatique  
GRAPA / AGRAFO / STAPLE / AGRAFE  
A18 coil / A19 coil  
PRESIÓN / PRESSÃO / PRESSURE / PRESSION  
4 - 7 atm



## mod 61 3200085

TIPO / TIPO / TYPE / TYPE  
Neumática / Pneumática / Pneumatic / Pneumatique  
GRAPA / AGRAFO / STAPLE / AGRAFE  
A18 coil  
PRESIÓN / PRESSÃO / PRESSURE / PRESSION  
4 - 7 atm



## A18 14 GAUGE

Código	Modelo	Long. mm
Código	Modelo	Comp. mm
Code	Model	Length mm
Code	Modèle	Long. mm

GALVANIZADO / GALVANIZED / GALVANISÉ		
4362092	Coil A18	9,5
	Bobina A18	
	Coil A18	
	Rouleau A18	

BÁSICO / BASIC / BASE		
4362093	Coil A18	9,5
	Bobina A18	
	Coil A18	
	Rouleau A18	

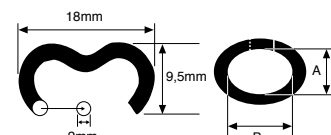

A MIN: 4mm MAX: 4,5mm  
B MIN: 4mm MAX: 7,5mm

## A19 15,5 GAUGE

Código	Modelo	Long. mm
Código	Modelo	Comp. mm
Code	Model	Length mm
Code	Modèle	Long. mm

GALVANIZADO / GALVANIZED / GALVANISÉ		
4362019	Coil A19	9,5
	Bobina A19	
	Coil A19	
	Rouleau A19	

BÁSICO / BASIC / BASE		
4362095	Coil A19	9,5
	Bobina A19	
	Coil A19	
	Rouleau A19	

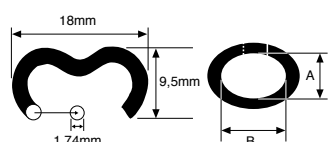

A MIN: 4mm MAX: 4,5mm  
B MIN: 4mm MAX: 7,5mm

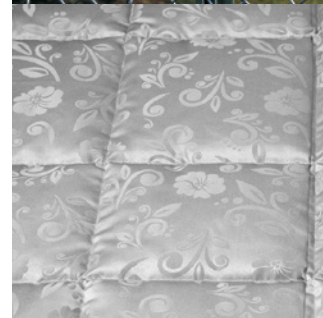

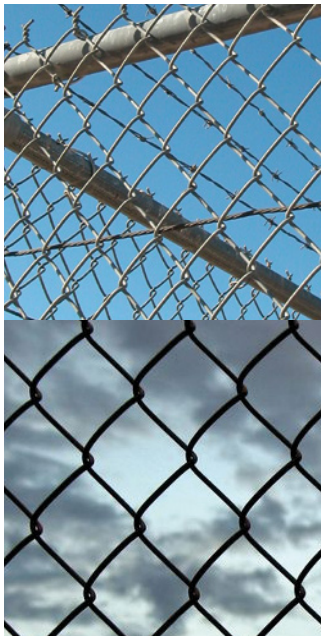
**A20**GRAPA / AGRAFO /  
STAPLE / AGRAFE

Código	Modelo	Long. mm
Código	Modelo	Comp. mm
Code	Model	Length mm
Code	Modèle	Long. mm

**4362070** ESTUCHE / CAIXA / BOX / ÉTUI: 1000  
Galvanizado reforzado 11  
Galvanizado reforçado  
Reinforced galvanized  
Galvanisé renforcé

**4362080** ESTUCHE / CAIXA / BOX / ÉTUI: 1000  
Plástica verde 11  
Plastificada verde  
Green coated  
Plastifiée verte

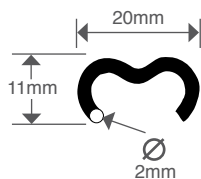

A MIN: 5,8mm MAX: 8mm  
B MIN: 6,5mm MAX: 9mm

**E Cercados, invernaderos y jaulas**

Cercados, para unir la valla a los alambres tensores y para unir rollos de vallado entre si.

**Invernaderos**, para fijar los cruces de alambre y que estos no se muevan en los diferentes tipos de invernaderos.

**Jaulas**, tanto para aves como conejos u otros animales, para unir en ángulos de 90° los diferentes paneles.

**P Cercas, estufas e gaiolas**

Cercas, para unir a vedação de arame aos arames tensores e para unir rolos de vedações de arame entre si.

**Estufas**, para fixar as intersecções de arame e para que estas não se desloquem nos diferentes tipos de estufas.

**Gaiolas**, tanto para aves como para coelhos ou outros animais, para unir os diferentes painéis em ângulos de 90 °.



## UK Enclosures, greenhouses and cages

Enclosures, to attach the fence to the wire tensioners and to fasten rolls of fencing to them.

**Greenhouses**, for fastening wire crossings to ensure they do not move in all types of greenhouses.

**Cages**, whether for fowl or rabbits or other animals, to join the 90° angles of different panels.

## F Enceintes, serres et cages

Enceintes, pour relier la clôture aux fils de fer tenseurs et pour relier les rouleaux de clôture entre eux.

**Serres** destinées à fixer les croix de fil de fer et à faire en sorte que celles-ci restent fixées, pour les différents types de serres.

**Cages**, aussi bien pour volailles que pour lapins ou autres animaux, pour relier les différents panneaux à des angles de 90°.



**mod 114**  
3200634

Grapa / Agrafo / Staple / Agrafe:  
**A20**  
Sin cargador / Sem carregador /  
Without magazine / Sans chargeur



**mod 115**  
3200645

Grapa / Agrafo / Staple / Agrafe:  
**A20**  
Cargador / Carregador /  
Magazine / Chargeur:  
**36 GRAPAS / AGRAFOS / STAPLES / AGRAFES**



**mod 121**  
3200705

Grapa / Agrafo / Staple / Agrafe:  
**A20**  
Cargador volteable  
Carregador reversível  
Reversible magazine  
Chargeur réversible:  
**36 GRAPAS / AGRAFOS / STAPLES / AGRAFES**



**mod 215**  
3200220

Grapa / Agrafo / Staple / Agrafe:  
**A20**  
Tipo / Tipo / Type / Type:  
**Neumática / Pneumática**  
**Pneumatic / Pneumatique**  
Capacidad / Capacidade  
Capacity / Capacité:  
**36 GRAPAS / AGRAFOS / STAPLES / AGRAFES**



### A18

GRAPA / AGRAFO  
STAPLE / AGRAFE

Código	Modelo	Long. mm
Código	Modelo	Comp. mm
Code	Model	Length mm
Code	Modèle	Long. mm

**4362062** ESTUCHE / CAIXA / BOX / ÉTUI: 1000  
Galvanizado (encintada) 9,5  
Galvanizado (encintado)  
Galvanized (taped)  
Galvanisé (enrubanée)

**4362072** ESTUCHE / CAIXA / BOX / ÉTUI: 3000  
Galvanizado (encolada) 9,5  
Galvanizado (encolada)  
Galvanized (glued)  
Galvanisé (encollée)

**4362097** ESTUCHE / CAIXA / BOX / ÉTUI: 1000  
Galvanizado (encolada) 9,5  
Galvanizado (encolada)  
Galvanized (glued)  
Galvanisé (encollée)

**4362056** ESTUCHE / CAIXA / BOX / ÉTUI: 1000  
Plástica verde 9,5  
Plastificada verde  
Green coated  
Plastifiée verte

**4362085** ESTUCHE / CAIXA / BOX / ÉTUI: 1000  
Inoxidable 9,5  
Inoxidável  
Stainless steel  
Inoxydable

### A16

GRAPA / AGRAFO  
STAPLE / AGRAFE

Código	Modelo	Long. mm
Código	Modelo	Comp. mm
Code	Model	Length mm
Code	Modèle	Long. mm

**4362046** ESTUCHE / CAIXA / BOX / ÉTUI: 1000  
Galvanizado reforzado 8,5  
Galvanizado reforçado  
Reinforced galvanized  
Galvanisé renforcé

**4362047** ESTUCHE / CAIXA / BOX / ÉTUI: 1000  
Inoxidable / Inoxidável 8,5  
Stainless steel / Inoxydable

**4362057** ESTUCHE / CAIXA / BOX / ÉTUI: 1000  
Plástica verde 8,5  
Plastificada verde  
Green coated  
Plastifiée verte

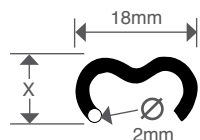

X A16: 8,5mm / A18: 9,5mm

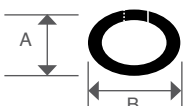

A MIN: 4mm MAX: 4,5mm  
B MIN: 4mm MAX: 7,5mm

# mod A18

# mod A16

14  
GAUGE

14  
GAUGE

## E Cercados, invernaderos y jaulas

Cercados, para unir la valla a los alambres tensores y para unir rollos de vallado entre si.

**Invernaderos**, para fijar los cruces de alambre y que estos se muevan en los diferentes tipos de invernaderos.

**Jaulas**, tanto para aves como conejos u otros animales, para unir en ángulos de 90° los diferentes paneles.

## P Cercas, estufas e gaiolas

Cercas, para unir a vedação de arame aos arames tensores e para unir rolos de vedações de arame entre si.

**Estufas**, para fixar as intersecções de arame e para que estas não se desloquem nos diferentes tipos de estufas.

**Gaiolas**, tanto para aves como para coelhos ou outros animais, para unir os diferentes painéis em ângulos de 90°.



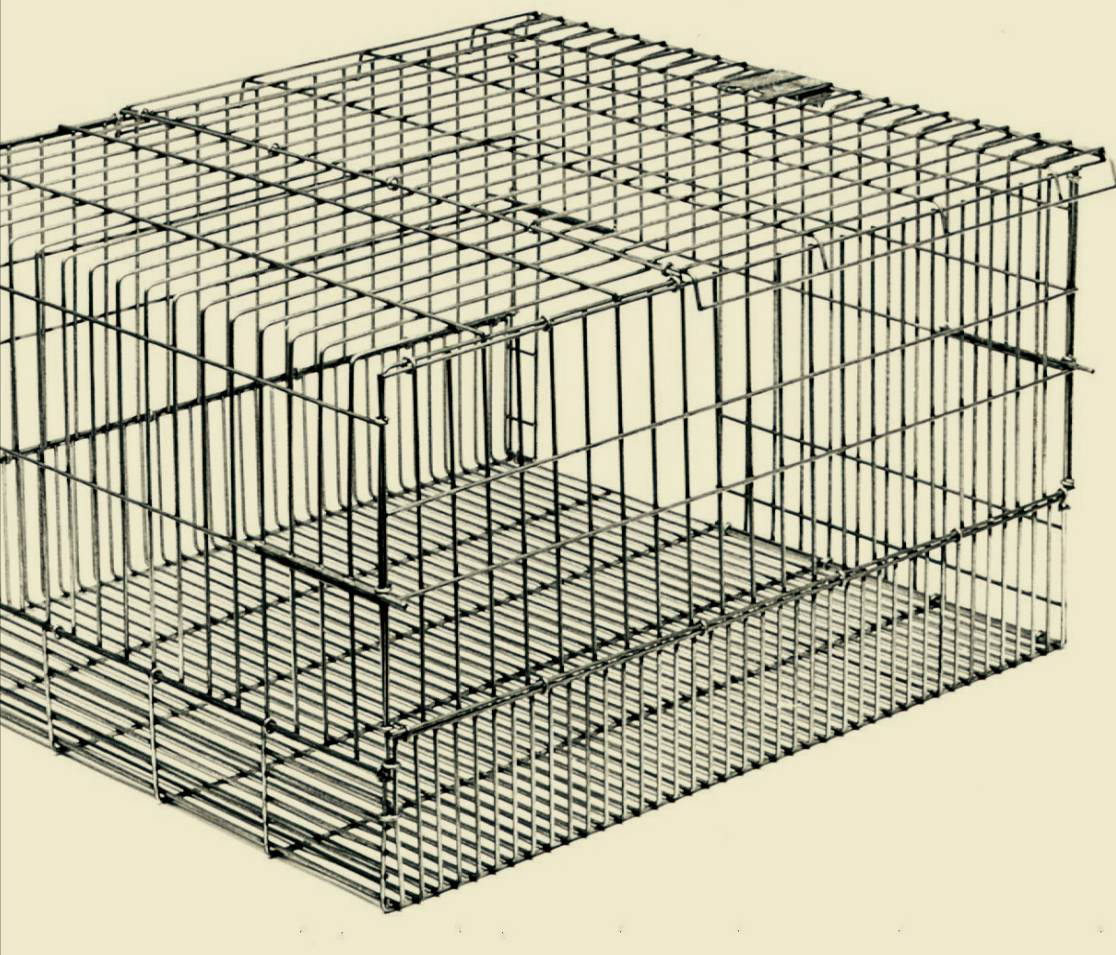

## **UK** Enclosures, greenhouses and cages

Enclosures, to attach the fence to the wire tensioners and to fasten rolls of fencing to them.

**Greenhouses**, for fastening wire crossings to ensure they do not move in all types of greenhouses.

**Cages**, whether for fowl or rabbits or other animals, to join the 90° angles of different panels.

## **F** Enceintes, serres et cages

Enceintes, pour relier la clôture aux fils de fer tenseurs et pour relier les rouleaux de clôture entre eux.

**Serres** destinées à fixer les croix de fil de fer et à faire en sorte que celles-ci restent fixées, pour les différents types de serres.

**Cages**, aussi bien pour volailles que pour lapins ou autres animaux, pour relier les différents panneaux à des angles de 90°.



**mod 111**  
3200581

Grapa / Agrafa / Staple / Agrafe:  
A16 / A18



**mod 110**  
3200593

Grapa / Agrafa / Staple / Agrafe:  
A16 / A18  
Cargador / Carregador /  
Magazine / Chargeur:

36 GRAPAS / AGRAFOS / STAPLES / AGRAFES



**mod 120**  
3200700

Grapa / Agrafa / Staple / Agrafe:  
A16 / A18  
Cargador volteable  
Carregador reversível  
Moveable magazine  
Chargeur réversible:

36 GRAPAS / AGRAFOS / STAPLES / AGRAFES



**mod 61**  
3200085

Grapa / Agrafa / Staple / Agrafe:  
A16 / A18  
Presión / Pressão Pressure / Pression:  
4 -7 atm  
Cargador / Carregador  
Magazine / Chargeur:

72 GRAPAS / AGRAFOS / STAPLES / AGRAFES



**mod 210**  
3200210

Grapa / Agrafa / Staple / Agrafe:  
A16 / A18  
Tipo / Tipo / Type / Type:  
Neumática / Pneumática  
Pneumatic / Pneumatique  
Capacidad / Capacidade  
Capacity / Capacité:

36 GRAPAS / AGRAFOS / STAPLES / AGRAFES



### Omega 20

GRAPA / AGRAFO  
STAPLE / AGRAFE

Código	Modelo	Long. mm
Código	Modelo	Comp. mm
Code	Model	Length mm
Code	Modèle	Long. mm

4363031	ESTUCHE / CAIXA / BOX / ÉTUI: 1,000	
	Galvanizado	11
	Galvanizado	
	Galvanized	
	Galvanisé	

4363021	ESTUCHE / CAIXA / BOX / ÉTUI: 200	
	Galvanizado	11
	Galvanizado	
	Galvanized	
	Galvanisé	

4363050	ESTUCHE / CAIXA / BOX / ÉTUI: 1,000	
	Plástificada verde	11
	Plastificado verde	
	Green coated	
	Plastifiée verte	

4363040	ESTUCHE / CAIXA / BOX / ÉTUI: 200	
	Plástificada verde	11
	Plastificado verde	
	Green coated	
	Plastifiée verte	

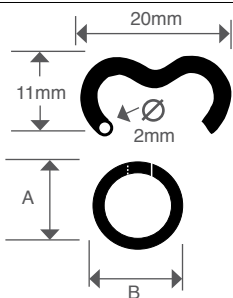

A MIN: 5,8mm MAX: 8,0mm  
B MIN: 6,5mm MAX: 9,0mm



**mod 116**  
3200670

Grapa / Agrafa / Staple / Agrafe:  
**Omega 20**  
Cargador / Carregador /  
Magazine / Chargeur:

36 GRAPAS / AGRAFOS / STAPLES / AGRAFES



**mod 117**  
3200675

Grapa / Agrafa / Staple / Agrafe:  
**Omega 20**

# omega 20

# omega 16

14  
GAUGE

17  
GAUGE

## **E** Cercados, invernaderos y jaulas

Cercados, para unir la valla a los alambres tensores y para unir rollos de vallado entre si.

**Invernaderos**, para fijar los cruces de alambre y que estos se puedan mover en los diferentes tipos de invernaderos.

**Jaulas**, tanto para aves como conejos u otros animales, para unir en ángulos de 90° los diferentes paneles.

## **P** Cercas, estufas e gaiolas

Cercas, para unir a vedação de arame aos arames tensores e para unir rolos de vedações de arame entre si.

**Estufas**, para fixar as intersecções de arame e para que estas não se desloquem nos diferentes tipos de estufas.

**Gaiolas**, tanto para aves como para coelhos ou outros animais, para unir os diferentes painéis em ângulos de 90 °.



**Omega 16**  
GRAPA / AGRAFO  
STAPLE / AGRAFE

Código	Modelo	Long. mm
Código	Modelo	Comp. mm
Code	Model	Length mm
Code	Modèle	Long. mm

**4363005** ESTUCHE / CAIXA / BOX / ÉTUI: 2,500  
Galvanizado 7,85  
Galvanized  
Galvanisé

**4363001** ESTUCHE / CAIXA / BOX / ÉTUI: 250  
Galvanizado 7,85  
Galvanized  
Galvanisé

**4363020** ESTUCHE / CAIXA / BOX / ÉTUI: 2,500  
Plástificada verde 7,85  
Plastificada verde  
Green coated  
Plastifiée verte

**4363011** ESTUCHE / CAIXA / BOX / ÉTUI: 250  
Plástificada verde 7,85  
Plastificada verde  
Green coated  
Plastifiée verte

**UK Enclosures, greenhouses and cages**

Enclosures, to attach the fence to the wire tensioners and to fasten rolls of fencing to them.

**Greenhouses**, for fastening wire crossings to ensure they do not move in all types of greenhouses.

**Cages**, whether for fowl or rabbits or other animals, to join the 90° angles of different panels.

**F Enceintes, serres et cages**

Enceintes, pour relier la clôture aux fils de fer tenseurs et pour relier les rouleaux de clôture entre eux.

**Serres** destinées à fixer les croix de fil de fer et à faire en sorte que celles-ci restent fixées, pour les différents types de serres.

**Cages**, aussi bien pour volailles que pour lapins ou autres animaux, pour relier les différents panneaux à des angles de 90°.

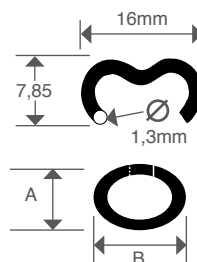

A MIN: 2,5mm MAX: 4,0mm  
B MIN: 3,5mm MAX: 8,0mm



**mod 107**  
3200676

Grapa / Agrafo / Staple / Agrafe:  
**Omega 16**  
Cargador / Carregador /  
Magazine / Chargeur:

36 GRAPAS / AGRAFOS / STAPLES / AGRAFES



**mod 108**  
3200677

Grapa / Agrafo / Staple / Agrafe:  
**Omega 16**



### A40

GRAPA / AGRAFO  
STAPLE / AGRAFE

Código	Modelo	Long. mm
Código	Modelo	Comp. mm
Code	Model	Length mm
Code	Modèle	Long. mm

**4363140** ESTUCHE / CAIXA / BOX / ÉTUI: 1000  
Galvanizado reforzado 17,8  
Galvanizado reforçado  
Reinforced galvanized  
Galvanisé renforcée

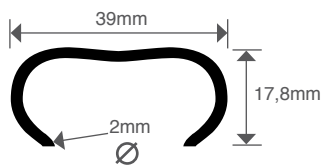

### mod 140

3200825

Grapa / Agrafó / Staple / Agrafe:  
A40  
Cargador / Carregador /  
Magazine / Chargeur:  
58 GRAPAS / AGRAFOS / STAPLES / AGRAFES

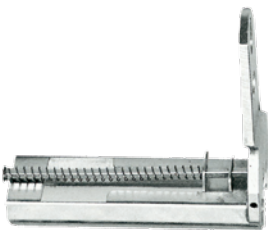

CARGADOR / CARREGADOR  
MAGAZINE / CHARGEUR  
11400912

Grapa / Agrafó / Staple / Agrafe:  
A40  
Anillos / Anéis / Rings / Anneaux:  
Ø 13-16mm

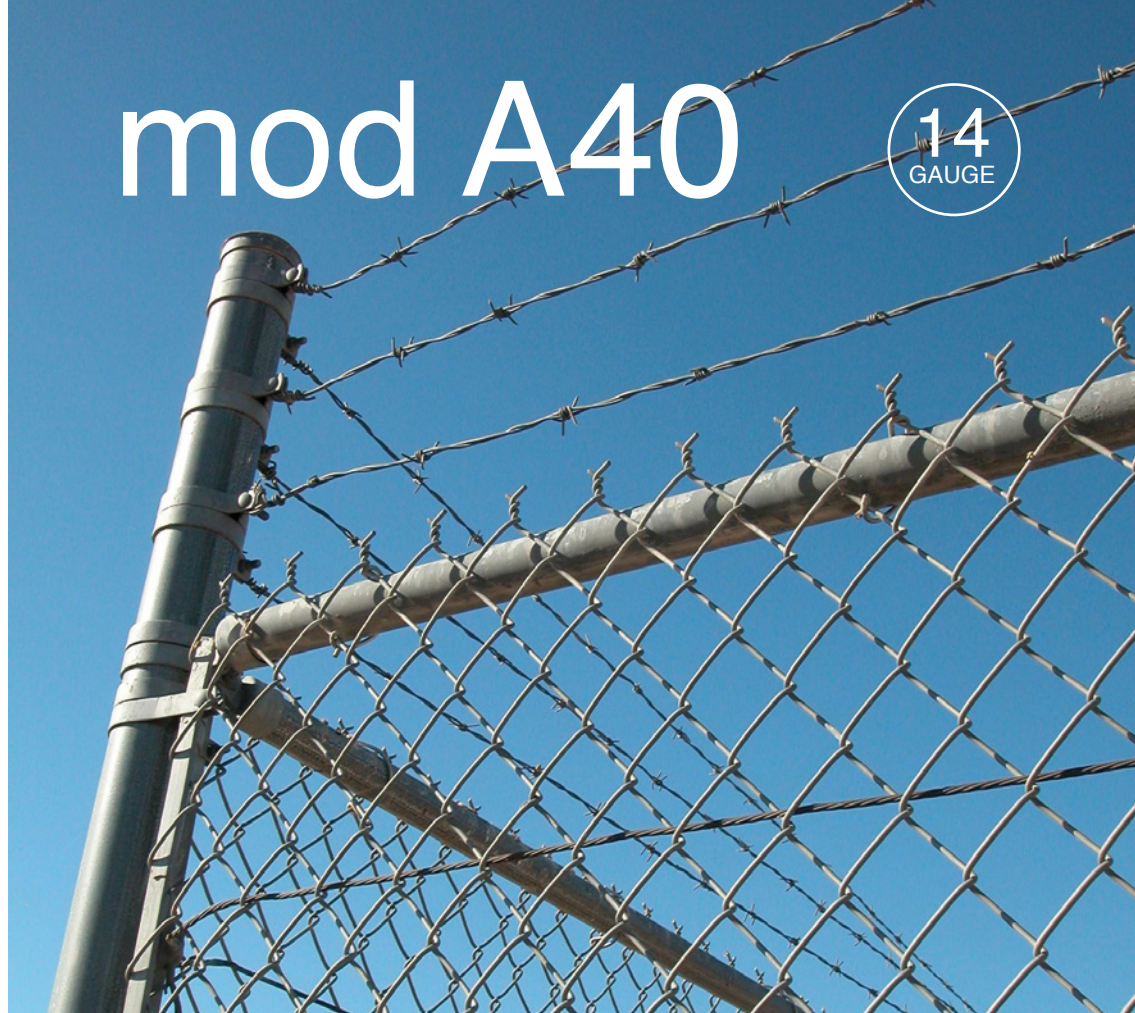

### E Fijación general

Novedad.

Hace anillos entre 12 y 16 mm de diámetro, cubre un hueco que no existía en el mercado y principalmente es utilizado para fijar alambres a tubos. Utilizada en vallados y en fabricación de jaulas.

### P Fixação geral

Novidade.

Faz argolas com diâmetro entre 12 e 16 mm, preenche uma lacuna que existia no mercado e, sobretudo, é utilizado para fixar arames a tubos. Utilizado em rolos de vedações de arame e no fabrico de gaiolas.

### UK General fastening

New.

Makes rings of between 12 and 16 mm in diameter, covering a gap that did not previously exist in the market, and mainly used for fastening wires to tubes. Used in fencing and for manufacturing cages.

### F Fixation générale

Nouveauté.

Permet de réaliser des anneaux d'entre 12 et 16 mm de diamètre, couvrant un besoin qui n'était pas satisfait sur le marché. Principalement utilisé pour fixer des fils de fer à des tubes. Utilisée sur des clôtures et pour la fabrication de cages.

# mod CL25

13  
GAUGE

ANILLADAS  
ANILHADOS  
HOG RINGS  
ANNELÉES

3



**CL25**  
GRAPA / AGRAFO  
STAPLE / AGRAFE

Código	Modelo	Long. mm
Código	Modelo	Comp. mm
Code	Model	Length mm
Code	Modèle	Long. mm
44922510	Galvanizado	15
	Galvanizado	
	Galvanized	
	Galvanisé	

## E Fijación general

Para realizar atados especiales, por resistencia (alambre de 2.2 mm) y/o por tamaño (hasta 11 mm de diámetro) en vallados, coberturas de valsas, etc. El mod125 con cargador en la palma de la mano para no molestar, es de accionamiento suave.

## P Fixação geral

Para realizar ataduras especiais, por resistência (arame de 2,2 mm) e/ou por tamanho (até 11 mm de diâmetro) em vedações de arame, coberturas de lagos artificiais para regadio, etc. O mod125 com carregador na palma da mão para não incomodar, é accionado suavemente.

## UK General fixing

For performing special ties, due to the resistance (2.2mm wire) and/or the size (up to 11 mm in diameter) on fencing, reservoir coverings, etc. mod.125 with loader in the palm of the hand so as not to bother, smooth action.

## F Fixation générale

Pour réaliser des attaches spéciales, par résistance (fil de fer de 2,2 mm) et/ou par taille (jusqu'à 11 mm de diamètre) sur des clôtures, pour recouvrir des étangs, etc. Le mod 125 avec chargeur dans la paume de la main pour plus de confort, est facile à actionner.

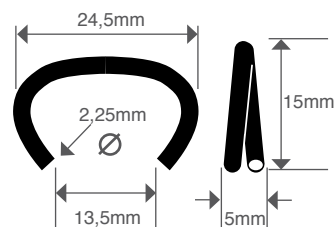

**mod 125p**  
32021125

Grapa / Agrafó / Staple / Agrafe:  
CL-25  
Cargador / Carregador /  
Magazine / Chargeur:  
40 GRAPAS / AGRAFOS / STAPLES / AGRAFES



### G29

GRAPA / AGRAFO  
STAPLE / AGRAFE

Código	Modelo	Long. mm
Código	Modelo	Comp. mm
Code	Model	Length mm
Code	Modèle	Long. mm

4302029	Galvaniz. reforzado	13,25
	Galvanizado reforçado	
	Reinforced galvanized	
	Galvanisé renforcée	

4302529	Inoxidable	13,25
	Inoxidável	
	Stainless steel	
	Inoxydable	

4303029	Plástica verde	13,25
	Plastificado verde	
	Green coated	
	Plastifiée verte	

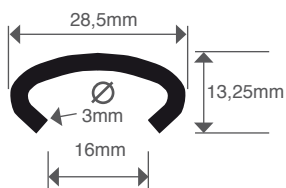

### G35

GRAPA / AGRAFO  
STAPLE / AGRAFE

Código	Modelo	Long. mm
Código	Modelo	Comp. mm
Code	Model	Length mm
Code	Modèle	Long. mm

4302035	Galvaniz. reforzado	16,75
	Galvanizado reforçado	
	Reinforced galvanized	
	Galvanisé renforcée	

4303035	Inoxidable	16,75
	Inoxidável	
	Stainless steel	
	Inoxydable	

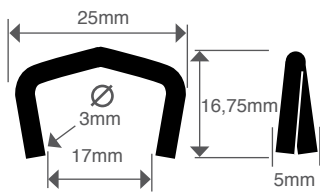

# mod G29

# mod G35

11  
GAUGE11  
GAUGE

## E Fijación para postes cremallera

Para fijar todo tipo de mallas de torsión a los novedosos postes.

**La grapa G29** por su ergonómico diseño proporciona la mayor resistencia a ser arrancada del poste.

**La grapa G35** con sus largas patas se clava en el poste no permitiendo que la malla se descuelgue.

**La grapadora mod 129** se puede utilizar fácilmente con una mano y es válida para los dos modelos de grapa.

## P Fixação para postes cremalheira

Para fixar todo o tipo de malhas de torção aos inovadores poste de cremalheira.

O **agrafo G29**, com o seu desenho ergonómico, proporciona uma resistência total ao seu arrancamento do poste.

O **agrafo G35** com as suas extremidades longas fica cravado no poste, não permitindo que a malha ceda.

O **agrafador mod 129** pode ser facilmente utilizado com uma mão, e aceita os dois modelos de agrafo.



## **UK** Fastening for perforated posts

For fastening all types of chain link to the brand new perforated posts.

Due to its ergonomic design, **the G29 staple** provides the greatest resistance from being pulled from the post.

**The G35 staple**, with its long legs are driven into the post preventing the chain link from sagging.

**The mod129 stapler** can easily be operated with one hand and is suitable for both staple models.

## **F** Fixation pour poteaux à crémaillère

Pour fixer toutes sortes de filets à torsion aux nouveaux poteaux à crémaillère.

L'**agrafe G29** fournit une résistance supérieure à l'arrachage du poteau, grâce à ses caractéristiques ergonomiques.

L'**agrafe G35** est fixée au poteau par ses longues extrémités, empêchant le filet de se décrocher.

L'**agrafeuse mod 129** peut-être utilisée facilement à une main et est valide pour les deux modèles d'agrafes.



**mod 129**  
3200129

Grapa / Agrafo Staple / Agrafe:  
G29 / G35

## mod CL50

11  
GAUGE**CL50**GRAPA / AGRAFO  
STAPLE / AGRAFE

Código	Modelo	Long. mm
Código	Modelo	Comp. mm
Code	Model	Length mm
Code	Modèle	Long. mm

4496015 Galvan 24

4306030	Inoxidable Aisi 304	24
	Inoxidável Aisi 304	
	Stainless steel Aisi 304	
	Inox Aisi 304	

4306025	Inoxidable Aisi 316	24
	Inoxidável Aisi 316	
	Stainless steel Aisi 316	
	Inox Aisi 316	

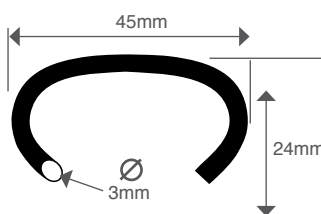
**mod sgm50**

1505020

Grapa / Agrafó / Staple / Agrafe:  
CL50

Tipo / Tipo / Type / Type:

Manual / Manual / Manual / Manuelle

Peso / Weight / Poids:

5,30 kg

Capacidad / Capacidade

Capacity / Capacité:

75 GRAPAS / AGRAFOS / STAPLES / AGRAFES

**mod sgn50**

1505050

Grapa / Agrafó / Staple / Agrafe:  
CL50

Tipo / Tipo / Type / Type:

Neumática / Pneumática  
Pneumatic / Pneumatique

Presión / Pressão

Pressure / Pression

5 - 8 atm

Peso / Weight / Poids:

6,60 kg

Capacidad / Capacidade

Capacity / Capacité:

100 GRAPAS / AGRAFOS / STAPLES / AGRAFES

**E Grapas para gaviones**

Para unir las jaulas y mallas creadas para hacer muros de piedras, principalmente en viales y canalizaciones.

**Sujección de alta resistencia: 270 kg/mm<sup>2</sup>.** Proporciona una fijación segura entre los diferentes paños de malla. Se emplean en la industria de la obra pública.

**P Fixação para gabiões**

Para unir as gaiolas e malhas fabricadas para fazer muros de pedras, principalmente em caminhos e canalizações.

**Fixação de alta resistência: 270 kg/mm<sup>2</sup>.** Garante uma fixação segura entre as diferentes telas de malha. É usado na indústria das obras públicas.

**UK Fastening for retaining walls**

For joining the cages and chain link created for making stone walls, mainly on highways and canalizations.

**Highly resistant support. 270 kg/mm<sup>2</sup>.** Provides a safe fastening between the different lengths of chain link. Used in the public works sector.

**F Fixation pour gabions**

Pour relier les cages et les filets créés pour la confection de murs en pierre, principalement sur les routes et les canalisations.

**Fixation haute résistance : 270 kg/mm<sup>2</sup>.** Fournit une fixation sûre entre les différents pans de filets. Utilisé dans l'industrie des travaux publics.



# grampillones

11  
GAUGE

PREGOS U · U NAILS · CRAMPILLONS



## E Grampillones

Galvanizados de uso agrícola.

Son utilizados para emparrados y clavado de alambres y mallas a estacas de madera. Otras posible aplicaciones en el campo de la jardinería. Envases de 5 kg. Embalajes formados por 4 envases (20 kg). Adaptado para su fácil manejo.

## P Pregos-U

Galvanizados para uso agrícola.

São utilizados para latadas e cravação de arames e malhas em estacas de madeira. Outras aplicações possíveis na área da jardinagem. Recipientes de 5 kg. Embalagens com 4 recipientes (20 kg). Adaptado para o seu fácil manejo.

## UK U nails

Galvanized for agricultural use.

Used for arbors and nailing wires and chain link to wooden posts. Other possible applications in the field of gardening. 5 kg packs. Packages of 4 packs (20 kg). Adapted for easy use.

## F Crampillons

Galvanisés pour usage agricole.

Ils sont utilisés pour les treilles et la fixation de fil de fer et de filets à des pieux en bois. Autres applications possibles dans le domaine de la jardinerie. Emballages de 5 kg.

ANILLADAS  
ANILHADOS  
HOG RINGS  
ANNELÉES

3



GRAMPILLONES / PREGOS U  
U-NAIL / GRAMPILLONS

Código	Longitud
Código	Comprimento
Code	Length
Code	Longueur

4993030	30mm
---------	------

4993035	35mm
---------	------

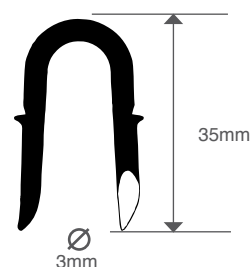
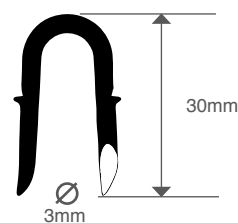

Util clavado grampillones  
Ferramenta pregos U  
U-nails tool  
Outil grampillons  
4993000







# 4

**COMPRESORES**  
**COMPRESSORES**  
**COMPRESSORS**  
**COMPRESSEURS**

6-15	76
6-25	76
PC1010	77
PC0968	77

# compresores silenciosos

## COMPRESORES SILENCIOSOS SILENT COMPRESSORS COMPRESSEURS SILENCIEUX

### 6-15

**3800058**

MOTOR / MOTEUR

1/2 CV

TENSIÓN / TENSÃO / VOLTAGE / TENSION

220V

CONSUMO / CONSUMPTION / CONSOMMATION

440 W

DESPLAZAMIENTO / CARREGA / DISPLACEMENT / DÉPLACEMENT

50 L / min.

PRESIÓN / PRESSÃO / PRESSURE / PRESSION

Max 8 atm

CALDERÍN / DEPÓSITO / BOILER / CHAUDIÈRE

15 L.

PESO / WEIGHT / POIDS

26 kg

ALTURA / HEIGHT / HAUTEUR

420mm

DIÁMETRO / DIÂMETRO / DIAMETRE / DIAMÈTRE

380mm

NIVEL DE SONORIDAD / NIVEL DE SONORIDAD

LOUDNESS LEVEL / NIVEAU SONORE

45 dB



**JUN-AIR®**

### 6-25

**3800042**

MOTOR / MOTEUR

1/2 CV

TENSIÓN / TENSÃO / VOLTAGE / TENSION

220V

CONSUMO / CONSUMPTION / CONSOMMATION

440 W

DESPLAZAMIENTO / CARREGA / DISPLACEMENT / DÉPLACEMENT

50 L / min.

PRESIÓN / PRESSÃO / PRESSURE / PRESSION

Max 8 atm

CALDERÍN / DEPÓSITO / BOILER / CHAUDIÈRE

25 L.

PESO / WEIGHT / POIDS

29 kg

ALTURA / HEIGHT / HAUTEUR

550mm

DIÁMETRO / DIÂMETRO / DIAMETRE / DIAMÈTRE

380mm

NIVEL DE SONORIDAD / NIVEL DE SONORIDAD

LOUDNESS LEVEL / NIVEAU SONORE

45 dB



**JUN-AIR®**



# compresores especiales para montadores

COMPRESSORES ESPECIAIS PARA APLICADORES  
SPECIAL COMPRESSORS FOR ASSEMBLERS  
COMPRESSEURS SPÉCIAUX POUR MONTEURS

## PC1010

Mini-compresor semi-silencioso  
Mini-compressor semi-silencioso  
Semi-silent mini-compressor  
Mini-compresseur semi-silencieuse

3800610

MOTOR / MOTEUR

0,5 CV

TENSIÓN / TENSÃO / VOLTAGE / TENSION

220V

DESPLAZAMIENTO / CARREGA / DISPLACEMENT / DÉPLACEMENT

28 L / min.

PRESIÓN / PRESSÃO / PRESSURE / PRESSION

Max 10 atm

CALDERÍN / DEPÓSITO / BOILER / CHAUDIÈRE

3,8 L.

PESO / WEIGHT / POIDS

9 kg

DIMENSIONES / DIMENSÕES / DIMENTIONS / DIMENSIONS

380 x 340 x 320 mm

NIVEL DE SONORIDAD / NIVEL DE SONORIDAD

LOUDNESS LEVEL / NIVEAU SONORE

68 dB



## PC0968

Compresor  
Compressor  
Compressor  
Compresseur

3800968

MOTOR / MOTEUR

1 CV

TENSIÓN / TENSÃO / VOLTAGE / TENSION

220V

DESPLAZAMIENTO / CARREGA

DISPLACEMENT / DÉPLACEMENT

40 L / min.

PRESIÓN / PRESSÃO / PRESSURE / PRESSION

Max 10 atm

CALDERÍN / DEPÓSITO / BOILER / CHAUDIÈRE

10 L.

PESO / WEIGHT / POIDS

17 kg

DIMENSIONES / DIMENSÕES / DIMENTIONS / DIMENSIONS

405 x 340 x 320 mm







**ADHESIVOS Y ESPUMA**  
**ADESIVOS E ESPUMAS**  
**ADHESIVES AND FOAM**  
**ADHÉSIFS ET MOUSSE**

Hot-melt, ø12mm	80
Hot-melt, ø15mm	81
Hot-melt, ø18mm	82
Hot-melt, ø43mm + cartuchos	83
Hot-melt, industrial	84
Espumas	85
FOAMS	
MOUSSES	



# hot-melt ø12mm

Código Código Code Code	Ref.. Ref.. Ref.. Ref..	Color Color Colour Couleur	Longitud mm Comprimento mm Length mm Longueur mm	Viscosidad (cps a 180°) Viscosidade (cps a 180°) Viscosity (cps at 180°) Viscosité (cps à 180°)	Tiempo abierto (seg) Tempo aberto (seg) Time open (sec) Temps ouvert (sec)	Temp. aplicación °C Temp. aplicação °C Application temp. °C Temp. application °C	Aplicaciones Aplicações Applications Applications
89120013	12001	Traslúcida/ Translúcida Translucent / Translucide	200/300	11000	40/60	170/210	Universal / Universelle
76127211	12073	Transparente / Transparent	200/300	10000	medio	170/210	Universal / Universelle
89120942	12094	Traslúcida/ Translúcida Translucent / Translucide	200/300	10000	medio	170/210	Hobby / Passe-temps
0430202	12020	Amarilla / Amarela Yellow / Jaune	300	4500	8/12	180/210	Papel y cartón / Papel e cartão Paper and cardboard / Papier et carton
0430302	12030	Traslúcida/ Translúcida Translucent / Translucide	200	9500	30/40	180/210	Cerámica y plásticos / Cerâmica e plásticos Ceramics and plastics / Céramiques et plastiques
0430355	12035	Transparente / Transparent	200	8500	30/35	180/210	Universal / Universelle
0430402	12040	Transparente / Transparent	200/300	9500	30/40	180/210	Universal / Universelle
0430502	12050	Amarilla / Amarelo Yellow / Jaune	200	8500	30/35	180/210	Cerámica y altas prestaciones Cerâmicas e alto desempenho Ceramics & high performance Céramiques et haute performance
4800498	12087	Transparente	300	8000	30/35	180/210	Universal / Universelle
0431012	12101	Ambar / Âmbar Amber / Ambre	300	9000	30/35	180/210	Madera y plásticos / Madeira e plástico Wood and plastics / Bois et plastiques
0431102	12110	Blanca / Branca White / Blanc	200/300	9500	27/30	180/210	Sanitarios y juntas / Saúde e articulações Bathrooms and joints / Santé et articulations
0431310	12131	Negra / Preta Black / Noire	200/300	9000	40/45	180/210	Universal, altas prestaciones / Universal, alta desempenho Universal, high performance / Universelle, haute performance
0430260	12260	Ambar / Âmbar Amber / Ambre	200	8000	30/35	180/210	Materiales difíciles, como metal, vidrio etc. Materiais difíceis, como metal, vidro, etc. Difficult materials such as metal, glass, etc.. Matériaux difficiles tels que le métal, le verre, etc.



## mod K2250

3702250

TIPO / TIPO / TYPE / TYPE

Electrica / Elétrico / Electric / Électrique

ADHESIVO / ADESIVO / ADHESIVE / ADHÉSIVE ø12mm

RENDIMIENTO / PERFORMANCE 0,7-1,2 Kg/h

CALENTAMIENTO / AQUECIMENTO / WARM UP / CHAUFFAGE 3-5 min aprox.

TENSIÓN / TENSÃO / VOLTAGE / TENSION 220V

POTENCIA / POTÊNCIA / POWER / PUISSANCE 220V



## mod HK612

3700612

TIPO / TIPO / TYPE / TYPE

Electrica / Elétrico / Electric / Électrique

ADHESIVO / ADESIVO / ADHESIVE / ADHÉSIVE ø12mm

RENDIMIENTO / PERFORMANCE 1,2-1,8 Kg/h

CALENTAMIENTO / AQUECIMENTO / WARM UP / CHAUFFAGE 3-5 min aprox.

TENSIÓN / TENSÃO / VOLTAGE / TENSION 220V

POTENCIA / POTÊNCIA / POWER / PUISSANCE 400W







# hot-melt ø15mm

Código Código Code Code	Ref. Ref. Ref. Ref.	Color Color Colour Couleur	Longitud mm Comprimento mm Length mm Longueur mm	Viscosidad (cps a 180°) Viscosidade (cps a 180°) Viscosity (cps at 180°) Viscosité (cps à 180°)	Tiempo abierto (seg) Tempo aberto (seg) Time open (sec) Temps ouvert (sec)	Temp. aplicación °C Temp. aplicação °C Application temp. °C Temp. application °C	Aplicaciones Aplicações Applications Applications
0430516	15020	Amarilla / Amarelo Yellow / Jaune	300	4500	8/12	180/210	Cartón y embalaje Papelaço e embalagens Paper and packaging Carton et emballage
89153011	15030	Traslúcida/ Translúcida Translucent / Translucide	200	9500	30/40	180/210	Cerámica y plásticos Cerâmica e plásticos Ceramics and plastics Céramiques et plastiques
0430515	15050	Amarilla / Amarelo Yellow / Jaune	200	8500	30/35	180/210	Cerámica y altas prestaciones Cerâmicas e alta desempenho Ceramics & high performance Céramiques et haute performance

## HK615 3700615

TIPO / TIPO / TYPE / TYPE

Electrica / Elétrico / Electric / Électrique

ADHESIVO / ADESIVO / ADHESIVE / ADHÉSIVE ø15mm

RENDIMIENTO / PERFORMANCE 1,8 - 2 Kg/h

CALENTAMIENTO / AQUECIMENTO / WARM UP / CHAUFFAGE 3-5 min aprox.

TENSIÓN / TENSÃO / VOLTAGE / TENSION 220V

POTENCIA / POTÊNCIA / POWER / PUISSANCE 450W



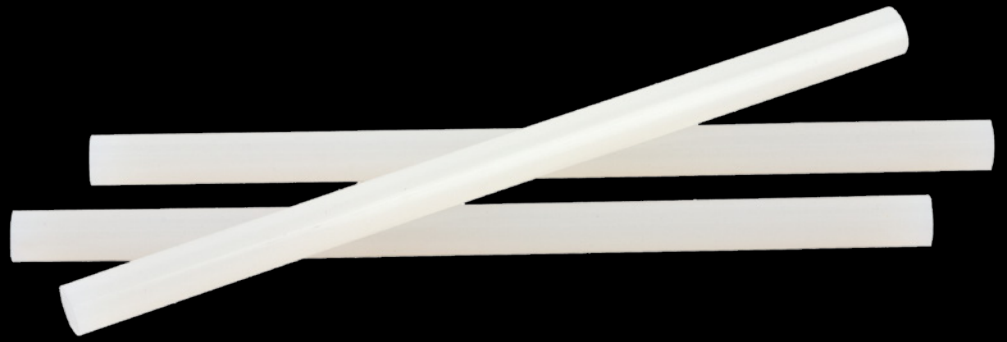

# hot-melt $\varnothing$ 18mm

Código Código Code Code	Ref. Ref. Ref. Ref.	Color Color Colour Couleur	Longitud mm Comprimento mm Length mm Longueur mm	Viscosidad (cps a 180°) Viscosidade (cps a 180°) Viscosity (cps at 180°) Viscosité (cps à 180°)	Tiempo abierto (seg) Tempo aberto (seg) Time open (sec) Temps ouvert (sec)	Temp. aplicación °C Temp. aplicação °C Application temp. °C Temp. application °C	Aplicaciones Aplicações Applications Applications
0430318	18030	Blanca / Branca White / Blanc	300	8500	30/40	180/210	Cerámica y plásticos Cerâmica e plásticos Ceramics and plastics Céramiques et plastiques
4800050	18050	Amarilla / Amarelo Yellow / Jaune	200	8500	30/35	180/210	Cerámica y altas prestaciones Cerâmicas e alta desempenho Ceramics & high performance Céramiques et haute performance
0430752	18055	Amarilla / Amarelo Yellow / Jaune	300	9500	25/30	180/210	Cerámica / Cerâmica Ceramics / Céramiques
8918001	18001	Traslúcida/ Traslúcida Translucent / Translucide	300	11000	40/60	170/210	Universal / Universelle
89518020	18020	Amarilla / Amarelo Yellow / Jaune	300	4000	10/20	170/210	Papel y cartón / Papel e papelão Paper and cardboard / Papier et carton



## mod HK618 3700618

TIPO / TIPO / TYPE / TYPE

Electrica / Elétrico / Electric / Électrique

ADHESIVO / ADESIVO / ADHESIVE / ADHÉSIVE  $\varnothing$ 18mm

RENDIMIENTO / EXECUÇÃO / PERFORMANCE / PERFORMANCE 2,5 Kg/h

CALENTAMIENTO / AQUECIMENTO / WARM UP / CHAUFFAGE 3-5 min aprox.

TENSIÓN / TENSÃO / VOLTAGE / TENSION 220V

POTENCIA / POTÊNCIA / POWER / PUISSANCE 400W





# hot-melt ø43mm cartuchos

CARTUCHOS  
 SLUGS  
 CARTOUCHES

Código	Ref.	Color	Longitud mm	Viscosidad (cps a 180°)	Tiempo abierto (seg)	Temp. aplicación °C	Aplicaciones
Código	Ref.	Color	Comprimento mm	Viscosidade (cps a 180°)	Tempo aberto (seg)	Temp. aplicação °C	Aplicações
Code	Ref.	Colour	Length mm	Viscosity (cps at 180°)	Time open (sec)	Application temp. °C	Applications
Code	Ref.	Coleur	Longueur mm	Viscosité (cps à 180°)	Temps ouvert (sec)	Temp. application °C	Applications

**HOT MELT Ø43 MM**

89543001	43001	Traslúcida/ Translucent	50	11000	40/60	170/210	Universal / Universelle
0434320	43020	Amarilla / Amarelo Yellow / Jaune	50	4000	30/40	170/190	Cartón y embalaje / Papelão e embalagens Paper and packaging / Carton et emballage
0434330	43030	Traslúcida/ Translucent	50	8500	25/40	170/210	Universal / Universelle
0434350	43050	Amarilla / Amarelo Yellow / Jaune	50	8500	30/40	170/210	Cerámica y plásticos / Cerâmica e plásticos Ceramics and plastics / Céramiques et plastiques

Código	Ref.	Color	Viscosidad (cps a 120°)	Tiempo abierto (seg)	Temp. aplicación °C	Aplicaciones
Código	Ref.	Color	Viscosidade (cps a 120°)	Tempo aberto (sg)	Temp. aplicação °C	Aplicações
Code	Ref.	Colour	Viscosity (cps at 120°)	Time open (sec)	Application temp. °C	Applications
Code	Ref.	Coleur	Viscosité (cps à 120°)	Temps ouvert (sec)	Temp. application °C	Applications

**CARTUCHOS / SLUGS / CARTOUCHES**

Material base: poliuretano reactivo / Material base: poliuretano reativo / Base material: Reactive polyurethane / Matériau base: polyuréthane réactive

4830060	0931	Blanca / Branca White / Blanc	13000	240	120/140	Automoción y construcción / Automotivo e construção Automobile and construction / Automobile et construction
-	1075	Blanca / Branca / White / Blanc	20000	60	120/140	Automoción / Automotivo / Automotive / Automobile
-	1504	Amarilla / Amarelo Yellow / Jaune	8000	1200	120/140	Automoción / Automotivo / Automotive / Automobile
-	1649	Blanca / Branca / White / Blanc	7000	480	100/120	Automoción y construcción / Automotivo e construção Automobile and construction / Automobile et construction
-	1709	Blanca / Branca / White / Blanc	25000	20	100/120	Tiempo abierto corto

**HB710 3601700**

APLICACIÓN / APLICAÇÃO / APPLICATION  
 Cordón / Cordão / Bead / Cordon

ADHESIVO / ADESIVO / ADHESIVE / ADHÉSIVE  
 ø43mm / Granza

RENDIMIENTO / EXECUÇÃO /  
 PERFORMANCE / PERFORMANCE

3,2 Kg/h (ø43mm) 1,3Kg/h (granza)

TENSIÓN / TENSÃO

VOLTAGE / TENSION 220V

POTENCIA / POTÊNCIA

POWER / PUISSANCE 400W



**HB710 SP (SPRAY) 3608700**

APLICACIÓN / APLICAÇÃO / APPLICATION  
 Spray

ADHESIVO / ADESIVO / ADHESIVE / ADHÉSIVE  
 ø43mm / Granza

RENDIMIENTO / EXECUÇÃO /  
 PERFORMANCE / PERFORMANCE

3,2 Kg/h (ø43mm) 1,3Kg/h (Granza)

TENSIÓN / TENSÃO

VOLTAGE / TENSION 220V

POTENCIA / POTÊNCIA

POWER / PUISSANCE 600W



**HB700K 3603700**

APLICACIÓN / APLICAÇÃO / APPLICATION  
 Cordón / Cordão / Bead / Cordon

ADHESIVO / ADESIVO / ADHESIVE / ADHÉSIVE  
 Cartucho

RENDIMIENTO / EXECUÇÃO /  
 PERFORMANCE / PERFORMANCE

0,7 Kg/h sin precalentar 2,0 Kg/h precalentado

TENSIÓN / TENSÃO

VOLTAGE / TENSION 220V

POTENCIA / POTÊNCIA

POWER / PUISSANCE 600W



**HB700K SP (SPRAY) 3604700**

APLICACIÓN / APLICAÇÃO / APPLICATION  
 Spray

ADHESIVO / ADESIVO / ADHESIVE / ADHÉSIVE  
 Cartucho

RENDIMIENTO / EXECUÇÃO /  
 PERFORMANCE / PERFORMANCE

0,7 Kg/h sin precalentar 2,0 Kg/h precalentado

TENSIÓN / TENSÃO

VOLTAGE / TENSION 220V

POTENCIA / POTÊNCIA

POWER / PUISSANCE 600W

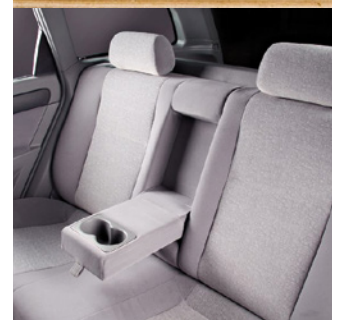



# hot-melt industrial

Código Código Code	Ref. Ref. Ref.	Color Color Colour Couleur	Viscosidad (cps a 120°) Viscosidade (cps a 120°) Viscosity (cps at 120°) Viscosité (cps à 120°)	Tiempo abierto (seg) Tempo aberto (seg) Time open (sec) Temps ouvert (sec)	Temp. aplicación °C Temp. aplicação °C Application temp. °C Temp. application °C	Aplicaciones Aplicações Applications Applications
<b>ESPIROLDADO / REDEMOINHO / SWIRL / TOURBILLONNER</b>						
4810067	10067	Ámbar / Ámbar / Amer / Ambre	1600	indefinido	140/170	Colchonería y tapicería / Colchões e estofados Mattresses and upholstery / Matelas et sellerie
4810082	10084	Ámbar / Ámbar / Amer / Ambre	800	indefinido	150/175	Colchonería y tapicería / Colchões e estofados Mattresses and upholstery / Matelas et sellerie
<b>CORDÓN / CORDÃO / CORDON / CORDON</b>						
4810805	10805	Ámbar / Ámbar / Amer / Ambre	1800	5/10	160/185	Colchonería y tapicería / Colchões e estofados Mattresses and upholstery / Matelas et sellerie
4810154	10154	Amarilla / Amarelo / Yellow / Jaune	900	20/30	140/170	Colchonería y tapicería / Colchões e estofados Mattresses and upholstery / Matelas et sellerie

## HB 5010 3605010

TIPO / TIPO / TYPE / TYPE

Electo-neumática / Electro-pneumático  
Electo-pneumatic / Electro-pneumatique

ADHESIVO / ADESIVO / ADHESIVE / ADHÉSIVE

Cubitos, bolsas / Cubos, sacos / Cubes, bags / Cubes, sacs

RENDIMIENTO / EXECUÇÃO / PERFORMANCE / PERFORMANCE

4,5 Kg/h

CAPACIDAD / CAPACIDADE / CAPACITIV / CAPACITÉ

4,5 L.



**E** El aplicador HB 5010 se recomienda especialmente para aplicaciones industriales de consumo continuo. Podemos disponer de dos mangueras calefactadas de longitud estándar de 1,2 a 6 metros, llegando hasta 12 metros bajo pedido, conectadas al mismo tanque. Las pistolas de aplicación conectadas a las mangueras pueden ser de aplicación en cordón o bien en spray.

**P** O aplicador HB 5010 é recomendado para aplicações industriais de consumo contínuo. Disponibilidade de ligar 2 mangueras de 6 metros cada no mesmo tanque. As pistola conectada às mangueras podem aplicar cola em fio ou em spray.

**UK** The HB 5010 is especially recommended for industrial applications of continuous consumption. There are two standard length heated hoses from 1.2 to 6 metres, or up to 12 metres on request, connected to the same tank. The spray gun connected to the hoses can be applied in bead or spray.

**F** L'aplicateur HB 5010 est spécialement recommandé pour des applications industrielles de consommation continuée. Il y a deux tuyeaux chauffées de largeur standard de 1.2 à 6 metres (disponibles jusqu'à 12 metres sous comande), connectées au même réservoir. Les pistolets d'application unies aux tuyeaux peuvent être en cordon ou spray.



# espumas

ESPUMAS  
 FOAMS  
 MOUSSES

Pistola aplicadora  
 Pistola aplicadora  
 Application gun  
 Pistolet applicateur  
 6202650



Limpiador de espuma de poliuretano  
 Limpador de espuma de poliuretano  
 Foam polyurethane cleaner  
 Mousse de nettoyage polyuréthane  
 4800011  
 CONTENIDO / CONTEÚDO / CONTENTS / CONTENU  
 500 cc



Espuma de poliuretano  
 Espuma de poliuretano  
 Polyurethane foam  
 Mousse de polyuréthane  
 4800016

CONTENIDO / CONTEÚDO  
 CONTENTS / CONTENU  
 750 cc

APLICACIÓN / APLICAÇÃO  
 APPLICATION / APPLICATION  
 Pistola / Pistola / Gun / Pistolet  
 RENDIMIENTO / EXECUÇÃO  
 PERFORMANCE / PERFORMANCE  
 45 L.



Espuma de poliuretano  
 Espuma de poliuretano  
 Polyurethane foam  
 Mousse de polyuréthane  
 4800017

CONTENIDO / CONTEÚDO  
 CONTENTS / CONTENU  
 750 cc

APLICACIÓN / APLICAÇÃO  
 APPLICATION / APPLICATION  
 Manual / Manuelle  
 RENDIMIENTO / EXECUÇÃO  
 PERFORMANCE / PERFORMANCE  
 45 L.







**TORNILLOS**  
**PARAFUSOS**  
**SCREWS**  
**VIS**

Tirafondo rosca-madera Pozi bicromatado LAG PARAFUSO DE MADEIRA POZI BICROMATADO POZI DICHROMATE LAG SCREW VIS À BOIS FENDUE BICHROMATÉ EMPREINTE POZI	88
Tirafondo rosca-madera Pozi cincado LAG PARAFUSO DE MADEIRA POZI ZINCO ZINC LAG SCREW POZI VIS À BOIS FENDUE ZINGUÉ EMPREINTE POZI	88
Tirafondo rosca-madera Torx bicromatado LAG PARAFUSO DE MADEIRA TORX BICROMATADO TORX DICHROMATE LAG SCREW VIS À BOIS FENDUE BICHROMATÉ EMPREINTE TORX	89
Tornillo DIN 571 cincado PARAFUSO ZINCO DIN 571 ZINC SCREW DIN 571 VIS DIN 571 ZINGUÉ	89
Tirafondo rosca-madera Torx FWS bicromatado LAG PARAFUSO DE MADEIRA TORX FWS BICROMATADO TORX FWS DICHROMATE LAG SCREW VIS À BOIS TORX FWS BICHROMATÉ	90
Puntas para atornillar BITES PARAFUSO SCREW TIPS POINTES DE VIS	90
ADS-UF	91
mod ADS-2025 RD	91
mod ADS-2010 RD	91
mod ADS-2040 RD	91
mod ADS-2045 RD	91



# tirafondo rosca-madera pozi bicromatado

LAG PARAFUSO DE MADEIRA POZI BICROMATADO  
POZI DICHROMATE LAG SCREW  
VIS À BOIS FENDUE BICHROMATÉ EMPREINTE POZI

Código Código Code Code	Dimensión Medidas Dimension Dimension	Código Código Code Code	Dimensión Medidas Dimension Dimension	Código Código Code Code	Dimensión Medidas Dimension Dimension
50222510	2,5 x 10	50224050	4,0 x 50	50225050	5,0 x 50
50222512	2,5 x 12	502240501	4,0 x 50 R.Comp	502250501	5,0 x 50 R.Comp
50222516	2,5 x 16	50224060	4,0 x 60	50225060	5,0 x 60
50222520	2,5 x 20	502240601	4,0 x 60 R.Comp	502250601	5,0 x 60 R.Comp
50222525	2,5 x 25	50224045	4,0 x 70	50225070	5,0 x 70
50223016	3,0 x 16	502240701	4,0 x 70 R.Comp	502250701	5,0 x 70 R.Comp
50223025	3,0 x 25	50224080	4,0 x 80	50225080	5,0 x 80
50223030	3,0 x 30	50224516	4,5 x 16	50225090	5,0 x 90
50223035	3,0 x 35	50224520	4,5 x 20	50225100	5,0 x 100
50223512	3,5 x 12	50224525	4,5 x 25	50226040	6,0 x 40
50223516	3,5 x 16	50224530	4,5 x 30	50226050	6,0 x 50
50223520	3,5 x 20	50224535	4,5 x 35	502260501	6,0 x 50 R.Comp
50223525	3,5 x 25	50224540	4,5 x 40	50226060	6,0 x 60
50223530	3,5 x 30	50224545	4,5 x 45	502260601	6,0 x 60 R.Comp
50223535	3,5 x 35	50224550	4,5 x 50	50226070	6,0 x 70
50223540	3,5 x 40	502245501	4,5 x 50 R.Comp	502260701	6,0 x 70 R.Comp
50223545	3,5 x 45	50224555	4,5 x 55	50226080	6,0 x 80
50223550	3,5 x 50	50224560	4,5 x 60	50226090	6,0 x 90
502235501	3,5 x 50 R.Comp	502245601	4,5 x 60 R.Comp	502260100	6,0 x 100
50223560	3,5 x 60	50224570	4,5 x 70	502260110	6,0 x 110
50224012	4,0 x 12	502245701	4,5 x 70 R.Comp	502260120	6,0 x 120
50224016	4,0 x 16	50224580	4,5 x 80	502260130	6,0 x 130
50224020	4,0 x 20	50225020	5,0 x 20	502260140	6,0 x 140
50224025	4,0 x 25	50225025	5,0 x 25	502260160	6,0 x 160
50224030	4,0 x 30	50225030	5,0 x 30	502260180	6,0 x 180
50224035	4,0 x 35	50225035	5,0 x 35	502260200	6,0 x 200
50224040	4,0 x 40	50225040	5,0 x 40		
50224045	4,0 x 45	50225045	5,0 x 45		



# tirafondo rosca-madera pozi cincado

LAG PARAFUSO DE MADEIRA POZI ZINCO  
ZINC LAG SCREW POZI  
VIS À BOIS FENDUE ZINGUÉ EMPREINTE POZI

Código Código Code Code	Dimensión Medidas Dimension Dimension	Código Código Code Code	Dimensión Medidas Dimension Dimension	Código Código Code Code	Dimensión Medidas Dimension Dimension
50242512	2,5 x 12	50243540	3,5 x 40	50244060	4,0 x 60
50242516	2,5 x 16	50243545	3,5 x 45	502440601	4,0 x 60 R.Comp
50243016	3,0 x 16	50243550	3,5 x 50	50244540	4,5 x 40
50243020	3,0 x 20	502435501	3,5 x 50 R.Comp	50244550	4,5 x 50
50243025	3,0 x 25	50244016	4,0 x 16	50244560	4,5 x 60
50243030	3,0 x 30	50244020	4,0 x 20	50244570	4,5 x 70
50243512	3,5 x 12	50244025	4,0 x 25	50244580	4,5 x 80
50243516	3,5 x 16	50244030	4,0 x 30	50245050	5,0 x 50
50243520	3,5 x 20	50244035	4,0 x 35	50245060	5,0 x 60
50243525	3,5 x 25	50244040	4,0 x 40	50245070	5,0 x 70
50243530	3,5 x 30	50244050	4,0 x 50		
50243535	3,5 x 35	502440501	4,0 x 50 R.Comp		



# tirafondo rosca-madera torx bicromatado

LAG PARAFUSO DE MADEIRA TORX BICROMATADO  
TORX DICHROMATE LAG SCREW  
VIS À BOIS FENDUE BICHROMATÉ EMPREINTE TORX

Código Código Code Code	Dimensión Medidas Dimension Dimension	Código Código Code Code	Dimensión Medidas Dimension Dimension	Código Código Code Code	Dimensión Medidas Dimension Dimension
50283020	3,0 x 20	50284050	4,0 x 50	50285060	5,0 x 60
50283025	3,0 x 25	50284060	4,0 x 60	50285070	5,0 x 70
50283030	3,0 x 30	50284070	4,0 x 70	50285080	5,0 x 80
50283035	3,0 x 35	50284080	4,0 x 80	50285090	5,0 x 90
50283512	3,5 x 12	50284516	4,5 x 16	50285100	5,0 x 100
50283516	3,5 x 16	50284520	4,5 x 20	50286040	6,0 x 40
50283520	3,5 x 20	50284530	4,5 x 30	50286050	6,0 x 50
50283525	3,5 x 25	50284535	4,5 x 35	50286060	6,0 x 60
50283530	3,5 x 30	50284540	4,5 x 40	50286070	6,0 x 70
50283535	3,5 x 35	50284545	4,5 x 45	50286080	6,0 x 80
50283540	3,5 x 40	50284550	4,5 x 50	50286090	6,0 x 90
50283545	3,5 x 45	50284555	4,5 x 55	50286100	6,0 x 100
50283550	3,5 x 50	50284560	4,5 x 60	502860110	6,0 x 110
50284016	4,0 x 16	50284570	4,5 x 70	502860120	6,0 x 120
50284020	4,0 x 20	50284580	4,5 x 80	502860130	6,0 x 130
50284025	4,0 x 25	50285030	5,0 x 30	502860140	6,0 x 140
50284030	4,0 x 30	50285035	5,0 x 35	502860160	6,0 x 160
50284035	4,0 x 35	50285040	5,0 x 40	502860180	6,0 x 180
50284040	4,0 x 40	50285045	5,0 x 45	502860200	6,0 x 200
50284045	4,0 x 45	50285050	5,0 x 50		

TORNILLOS  
PARAFUSOS  
SCREWS  
VIS

6



# tornillo DIN 571 cincado

PARAFUSO ZINCO DIN 571  
ZINC SCREW DIN 571  
VIS DIN 571 ZINGUÉ

Código Código Code Code	Dimensión Medidas Dimension Dimension	Código Código Code Code	Dimensión Medidas Dimension Dimension
505715030	5 x 30	5057110060	10 x 60
505715040	5 x 40	5057110070	10 x 70
505715050	5 x 50	5057110080	10 x 80
505716030	6 x 30	5057110100	10 x 100
505716040	6 x 40	5057110120	10 x 120
505716050	6 x 50	5057112100	12 x 100
505716060	6 x 60	5057112120	12 x 120
505716070	6 x 70		
505716080	6 x 80		
5057160100	6 x 100		
505717040	7 x 40		
505717050	7 x 50		
505717060	7 x 60		
505717080	7 x 80		
505718040	8 x 40		
505718050	8 x 50		
505718060	8 x 60		
505718070	8 x 70		
505718080	8 x 80		
505718090	8 x 90		

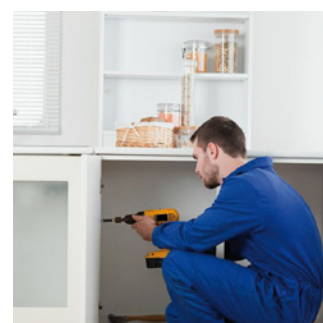



# tirafondo rosca-madera torx fws bicromatado

LAG PARAFUSO DE MADEIRA TORX FWS BICROMATADO  
TORX FWS DICHROMATE LAG SCREW  
VIS À BOIS TORX FWS BICHROMATÉ

Código Código Code Code	Dimensión Medidas Dimension Dimension
508080120	8 x 120
508080140	8 x 140
508080160	8 x 160
508080180	8 x 180
508080200	8 x 200
508080220	8 x 220
508080240	8 x 240

Código Código Code Code	Dimensión Medidas Dimension Dimension
508080260	8 x 260
508080280	8 x 280
508080300	8 x 300
508010200	10 x 200
508010220	10 x 220
508010240	10 x 240
508010260	10 x 260

Código Código Code Code	Dimensión Medidas Dimension Dimension
508010280	10 x 280
508010300	10 x 300
508010320	10 x 320
508010340	10 x 340
508010360	10 x 360
508010380	10 x 380
508010400	10 x 400

• Estrías bajo la cabeza para facilitar el avellanado. Fresado especial para disminuir la fricción en la entrada del tirafondo. Paso de rosca rápido para reducir el tiempo de colocación. Rosca cortante en los primeros filetes de la rosca para facilitar la salida de la viruta. Punta fresada especial autopercorante.

• Stretch marks under the head to ease countersinking. Specially milled to reduce friction at the entrance of lag. Rapid thread pitch to reduce the time of placement. First tapping of the screw threads to facilitate the exit of the chip. Special self-drilling milled edge.

• As estrías sob a cabeça são concebidas de forma a aliviar a pressão final. Rosca desenhada de forma a reduzir o atrito de fixação. Passo de rosca rápido de forma a reduzir o tempo de colocação. Ponta fresada autopercorante.

• Vergetures sous la tête pour faciliter le fraisage. Spécialement moulu pour réduire la friction à l'entrée de décalage. Pas du filetage rapide pour réduire le temps de placement. Premières pas de filets coupants pour faciliter la sortie de la puce. Spécial auto-perçage fraisé bord.



# puntas para atornillar

BITES PARAFUSO  
SCREW TIPS  
POINTES DE VIS

Código Código Code Code	Descripción Medidas Dimension Dimension	Longitud mm Comprimento mm Length mm Longueur mm	Diámetro mm Diâmetro mm Diameter mm Diamètre mm
80100221	PZ N°1	25	2,5
80100210	PZ N°1	50	2,5
80100222	PZ N°2	25	3-5
80100215	PZ N°2	50	3-5
80100225	PZ N°3	25	5,5-6
80100219	PZ N°3	50	5,5-6
80100535	TORX T15	25	3,5
80105035	TORX T15	50	3,5
80102025	TORX T20	25	4
80102050	TORX T20	50	4
80102525	TORX T25	25	4,5-5
80102550	TORX T25	50	4,5-5
80103025	TORX T30	50	6
80103050	TORX T30	50	6
80104025	TORX T40	25	8-10
80104050	TORX T40	50	8-10
85200040	ADS-1168 PZ N°1 45	-	-
85200035	ADS-1132 PZ N°2 45	-	-

# equipos automáticos para tirafondo suelto

TORNILLOS  
PARAFUSOS  
SCREWS  
VIS

6

## ADS-UF

3501105

ALIMENTADOR AUTOMÁTICO DE TIRAFONDOS: ENTRE 30 Y 80 TORNILLOS / MINUTO.

PARAFUSOS ALIMENTADOR: ENTRE 30 E 80 PARAFUSOS / MINUTO.

AUTOMATIC SCREW FEEDER: BETWEEN 30 AND 80 SCREWS / MINUTE.

FEEDER AUTOMATIQUE DE VIS: ENTRE 30 ET 80 VIS / MINUTE

TIPO / TIPO / TYPE / TYPE Neumática / Pneumática / Pneumatic / Pneumatique

TORNILLO / PARAFUSO / SCREW / VIS Ø 2,5 / 5mm. 10 - 50 mm

PRESIÓN / PRESSÃO / PRESSURE / PRESSION 5 - 7 atm



## mod ADS-2025 RD

3501125

TIPO / TIPO / TYPE / TYPE

Neumática / Pneumática / Pneumatic / Pneumatique

TORNILLO / PARAFUSO / SCREW / VIS

Ø 2,5 / 3mm. 10 - 20 mm

PRESIÓN / PRESSÃO / PRESSURE / PRESSION

4 - 7 atm

ACCIONAMIENTO POR CONTACTO · AÇÃO DE CONTATO

CONTACT ACTION · CONTACTEZ L'ACTION



## mod ADS-2010 RD

3501110

TIPO / TIPO / TYPE / TYPE

Neumática / Pneumática / Pneumatic / Pneumatique

TORNILLO / PARAFUSO / SCREW / VIS

Ø 3,5 / 5mm. 16 - 50 mm

PRESIÓN / PRESSÃO / PRESSURE / PRESSION

4 - 7 atm

ACCIONAMIENTO POR CONTACTO · AÇÃO DE CONTATO

CONTACT ACTION · CONTACTEZ L'ACTION



## mod ADS-2040 RD

3501140

TIPO / TIPO / TYPE / TYPE

Neumática / Pneumática / Pneumatic / Pneumatique

TORNILLO / PARAFUSO / SCREW / VIS

Ø 2,5 / 3mm. 10 - 20 mm

PRESIÓN / PRESSÃO / PRESSURE / PRESSION

4 - 7 atm

ACCIONAMIENTO POR CONTACTO · AÇÃO DE CONTATO

CONTACT ACTION · MISE EN MARCHÉ PAR CONTACTE



## mod ADS-2045 RD

3501145

TIPO / TIPO / TYPE / TYPE

Neumática / Pneumática / Pneumatic / Pneumatique

TORNILLO / PARAFUSO / SCREW / VIS

Ø 3,5 / 5mm. 16 - 50 mm

PRESIÓN / PRESSÃO / PRESSURE / PRESSION

4 - 7 atm

ACCIONAMIENTO POR CONTACTO · AÇÃO DE CONTATO

CONTACT ACTION · MISE EN MARCHÉ PAR CONTACTE

